

design
make
play

SutcliffePlay

Waggon Lane
Upton Pontefract
West Yorkshire WF9 1JS
Telephone +44 (0) 1977 653200
Facsimile +44 (0) 1977 653222
info@sutcliffeplay.co.uk
www.sutcliffeplay.co.uk



JUNGLE



NAUTILUS

Jungle/ Nautilus Themed Unit THU005

Installation Instructions

THU005

Themed Unit Installation Instructions

- 1 Check using the parts list that you have all the components.
- 2 Plan the final position of the play equipment, ensuring there is sufficient space (consider the extent and HIC of surfacing (see plan). Stainless steel slides should face north or be shaded to prevent over heating.
- 3 Excavate the foundation holes in accordance with the plan and play level, ensuring holes are dug to an equal level relative to each other.
- 4 The main frame THF001 should be placed into the foundation holes, the distance between the vertical uprights to be 650mm, position the main deck between the two frame to ensure the correct position is achieved.
- 5 Assemble the panels onto the steel frame using the supplied brackets PZA700ZP and PZA705ZP.
- 6 Bolt on plastic slide ground fixing to underside of run-out section and place in foundation hole. Offer up slide entrance to slide fixing bracket and fix bolts through assembly and tree trunk/giraffe neck panels. The slide should be angled to ensure water does not collect at run-out section.
- 7 Assemble plank climber with side panels for 'Jungle' and 'Nautilus', attaching planks to brace side panels. Fix ground pedestals and place final assembly in to the foundation holes, hooking over on to the central frame, bolting in to place with 'U' brackets.

THU005

Themed Unit Installation Instructions

8 Sit the ramp assembly (THF121) in to the foundation holes and bolt in place using 'U' brackets.

9 When the unit is completely assembled, ensure the unit is completely level and in the correct position, then tighten all fixings prior to the concrete being poured. Float off upper surface to enable run-off away from frame uprights.

10 Ensure all exposed hex head bolts and lock nuts are capped off using the nut covers (most are yellow, but fit black ones to bolts through character's eyes).

11 The unit should be secured against use by any member of the public until the concrete has set and the appropriate depth and extent of safety surfacing has been installed (refer to installation plans).

12 Follow the maintenance instructions supplied (see page 14).

Use the panel fixing general sheet supplied to select the correct bolts from the fixing kit. We suggest fixing countersunk bolts first as other panels may be layered on top of them. It is important not to fully tighten the fixings until all panels have been assembled and the unit is stood within the foundation holes.

NB: During installation, care must be taken to prevent hazards to children. If you are at all unsure or have any questions, please contact the contracts department

THU005

Themed Unit
Panels & Parts List

design
make
play
SutcliffePlay

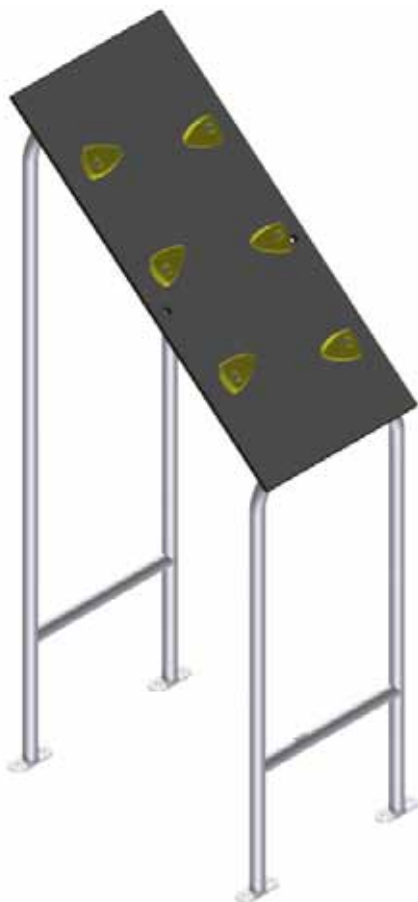

THF121
Ramp Assembly

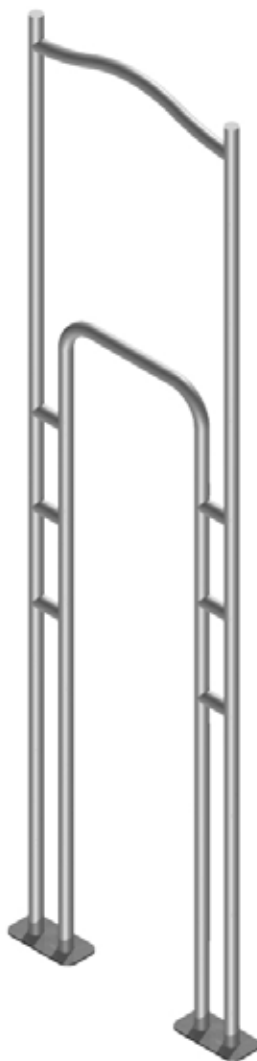

THF001GRY
Steel Frame



THD010
Transfer Deck

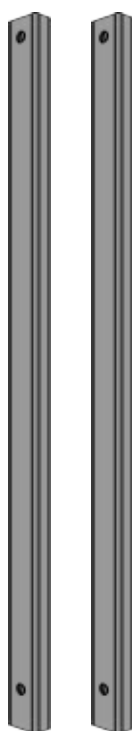

PED302
Plank Climber
Pedestal x 2



THF050R
Periscope /
Loud Hailer

THU005

Themed Unit Panel & Parts List

design
make
play
SutcliffePlay



THA107
Nautilus Ramp
Background Panel

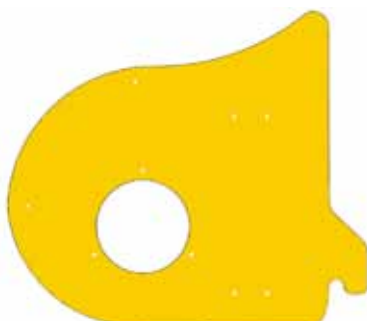

THP108
Nautilus Front Panel



THP027
Swimming Fish

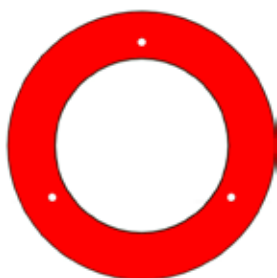

THP109
Nautilus Small Porthole



THA090
Jungle Ramp
Background Panel

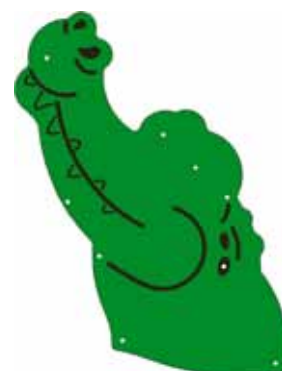

THP097
Jungle Crocodile Head
Panel



THP098
Crocodile Eyes Panel



THP099
Jungle River Panel



THD001
Hexaboard Deck

THU005

Themed Unit Panel & Parts List

design
make
play
SutcliffePlay



THP102
Nautilus Large Porthole

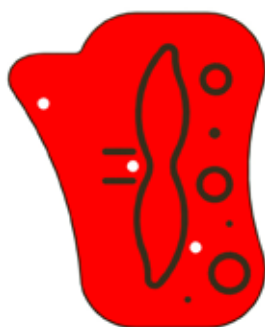

THP103
Nautilus Propeller Panel

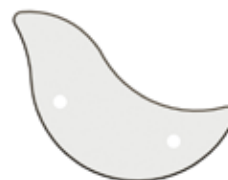

THP104
Nautilus Sea Foam
Panel x 2



THP100
Nautilus Sea
Background Panel



THP101
Nautilus Back Panel



THP096
Jungle Background
Panel



THD005
Plank Climber x 7



PZB016
Hand Grips x 7



THA091
Jungle Elephant Panel

THU005

Themed Unit Panel & Parts List

design
make
play
SutcliffePlay



THP092
Jungle Tree Trunk Panel



THP093
Jungle Giraffe Neck Panel



THP095-
Jungle Giraffe Eyes



THP094
Jungle Giraffe Head Panel



THP105
Nautilus Sky Panel



THA046
Jungle Treetop Panel

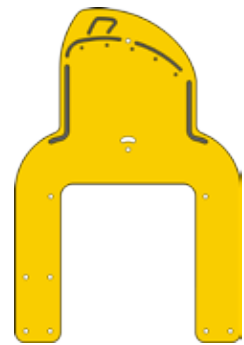

THP106
Nautilus Conning
Tower Panel



MZA304R
Nautilus Steering Wheel



x 3



x 2

THP110B/THP110Y
Nautilus Periscope
spacers x 5

THU005

Themed Unit Parts List

design
make
play
SutcliffePlay

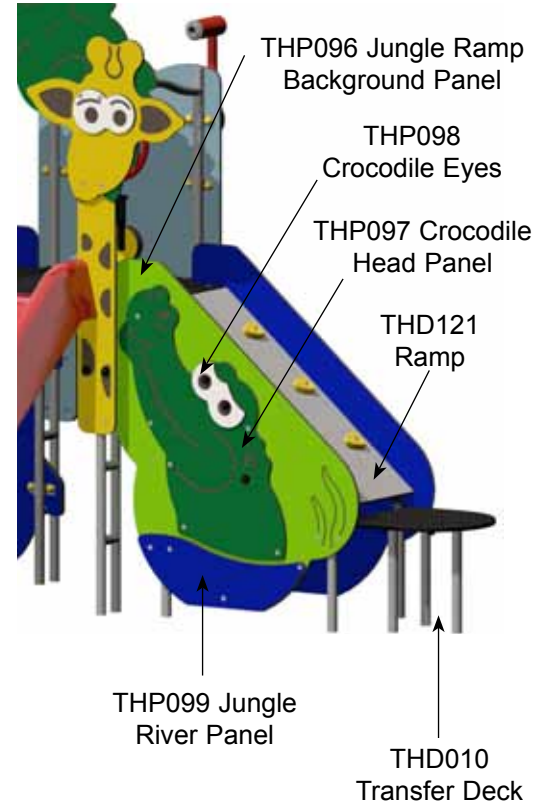
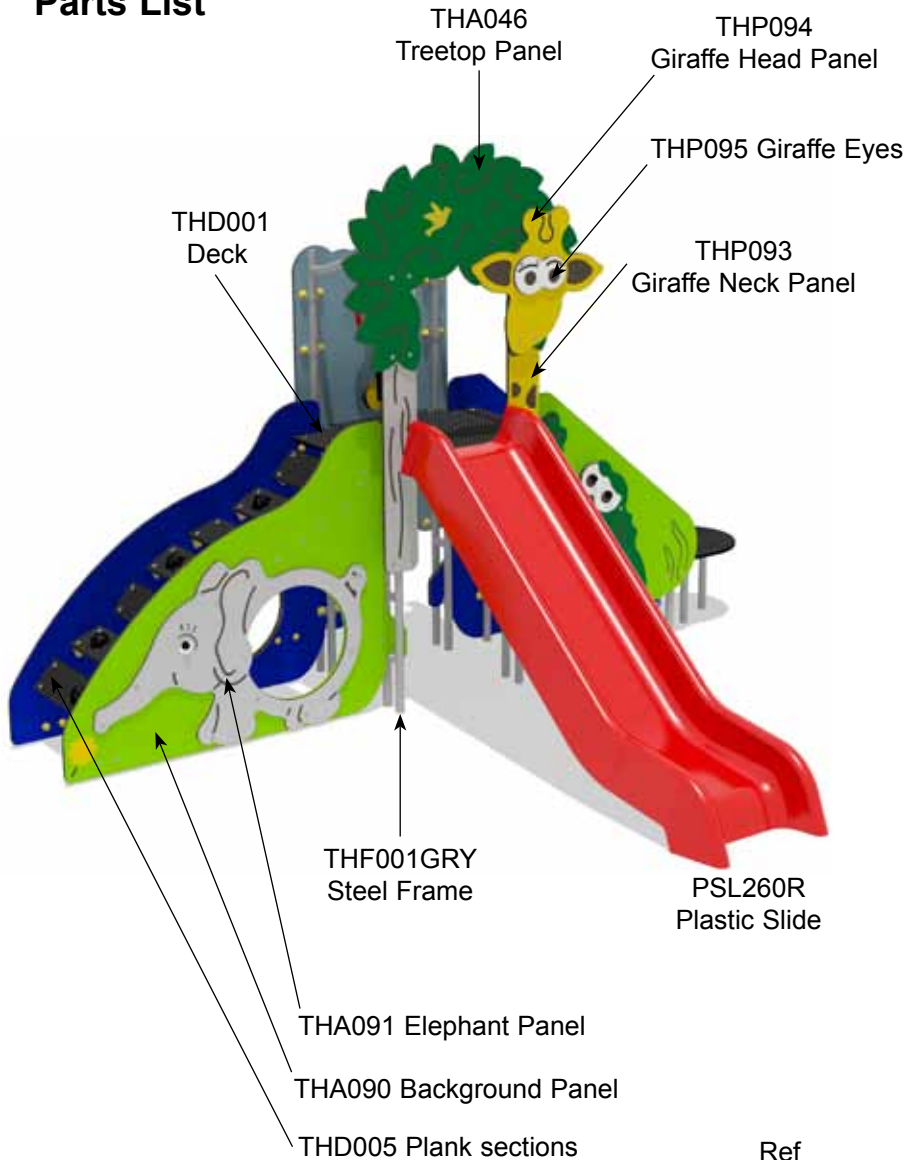

| Ref | Description | Qty |
|------------------------------------|--------------------------------------|-----|
| Jungle Ramp Side Panel | | |
| THP096 | Jungle Ramp Background Panel | 1 |
| THP097 | Jungle Crocodile Head Panel | 1 |
| THP098 | Jungle Crocodile Eyes | 1 |
| THP099 | Jungle River Panel | 1 |
| THD120 | Ramp Floor Panel | 1 |
| THF121 | Ramp Assembly | 1 |
| Jungle Plank Climb Side | | |
| THA090 | Jungle Plank Climb Background Panel | 1 |
| THA091 | Jungle Elephant Panel | 1 |
| THD005 | Jungle Plank Sections (see Nautilus) | 7 |
| Jungle Central Section Side | | |
| THP092 | Jungle Tree Trunk Panel | 1 |
| THP093 | Jungle Giraffe Neck Panel | 1 |
| THP094 | Jungle Giraffe Head Panel | 1 |
| THP095 | Jungle Giraffe Eyes | 1 |
| THA046 | Jungle Tree Top Panel | 1 |
| PSL260R | Plastic Slide | 1 |
| PSL250R | Slide Bracket | 1 |
| ORS056 | Slide Pedestal | 1 |

| Ref | Description | Qty |
|-----------|------------------------|-------|
| THF001GRY | Steel Frame Assembly | 2 |
| THD001 | Deck | 1 |
| THD010 | Transfer Deck Assembly | 1 |
| THU005F | Fixing Kit | 1 set |

THU005

Themed Unit Parts List



THD001 Hexaboard Deck

THD005 Climbing Plank

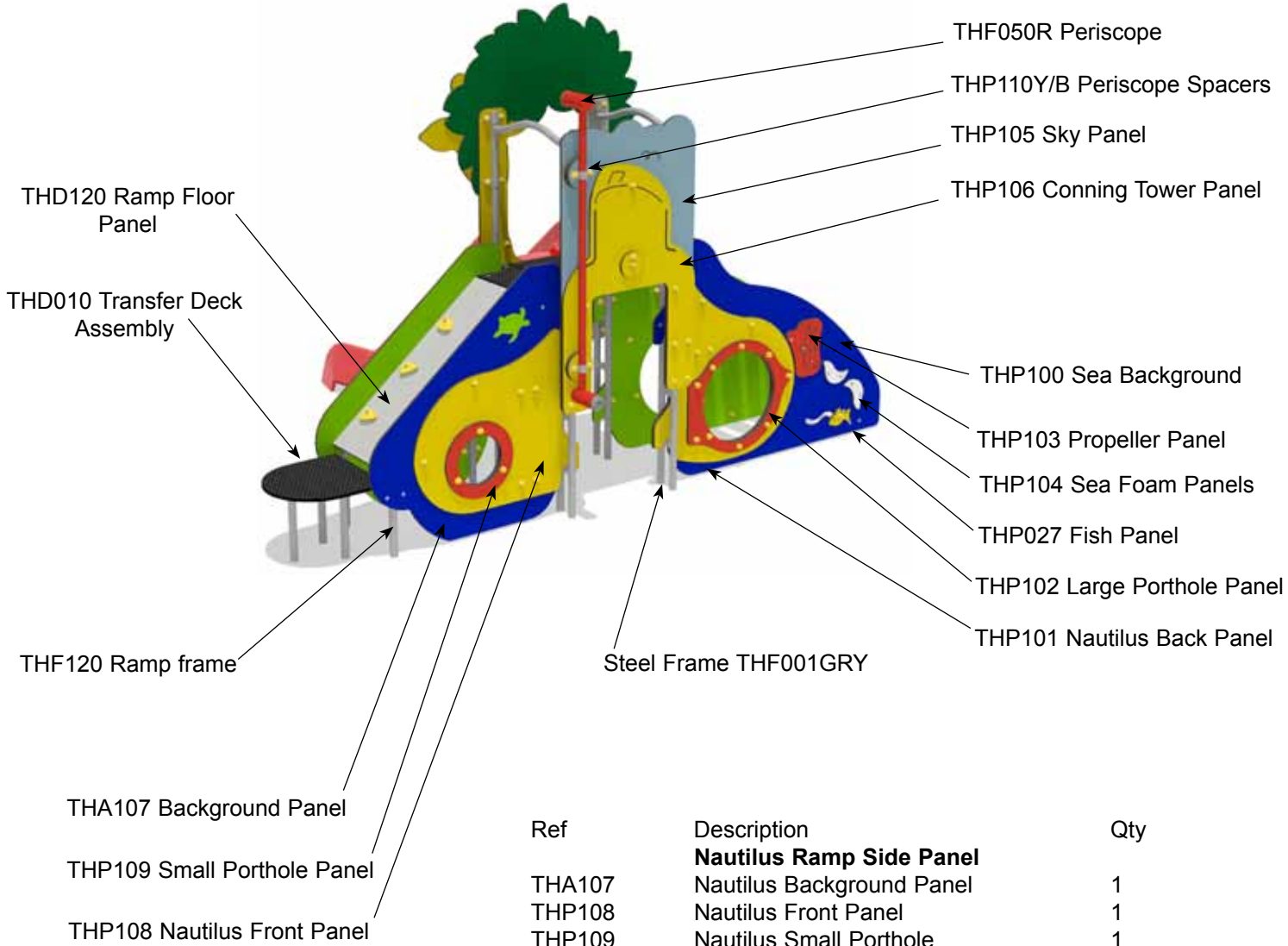

| Ref | Description | Qty |
|--------------------------------------|--------------------------------------|-----|
| Nautilus Ramp Side Panel | | |
| THA107 | Nautilus Background Panel | 1 |
| THP108 | Nautilus Front Panel | 1 |
| THP109 | Nautilus Small Porthole | 1 |
| THF121 | Ramp Assembly | 1 |
| Nautilus Plank Climb Side | | |
| THP100 | Nautilus Sea background | 1 |
| THP101 | Nautilus Back Panel | 1 |
| THP102 | Nautilus Large Porthole | 1 |
| THP103 | Nautilus Propeller | 1 |
| THP104 | Nautilus Sea Foam | 2 |
| THD005 | Nautilus Plank Sections | 7 |
| THP027 | Nautilus Swimming Fish | 1 |
| Nautilus Central Section Side | | |
| THP106 | Nautilus Conning Tower Panel | 1 |
| THP105 | Nautilus Sky Panel | 1 |
| MZA304 | Steering Wheel Panel | 1 |
| THF050R | Periscope Assembly | 1 |
| THP110Y/B | Periscope spacers (2 yellow, 3 blue) | 5 |

THU005

Themed Unit
Bracket Assembly

design
make
play
SutcliffePlay

Jungle Side

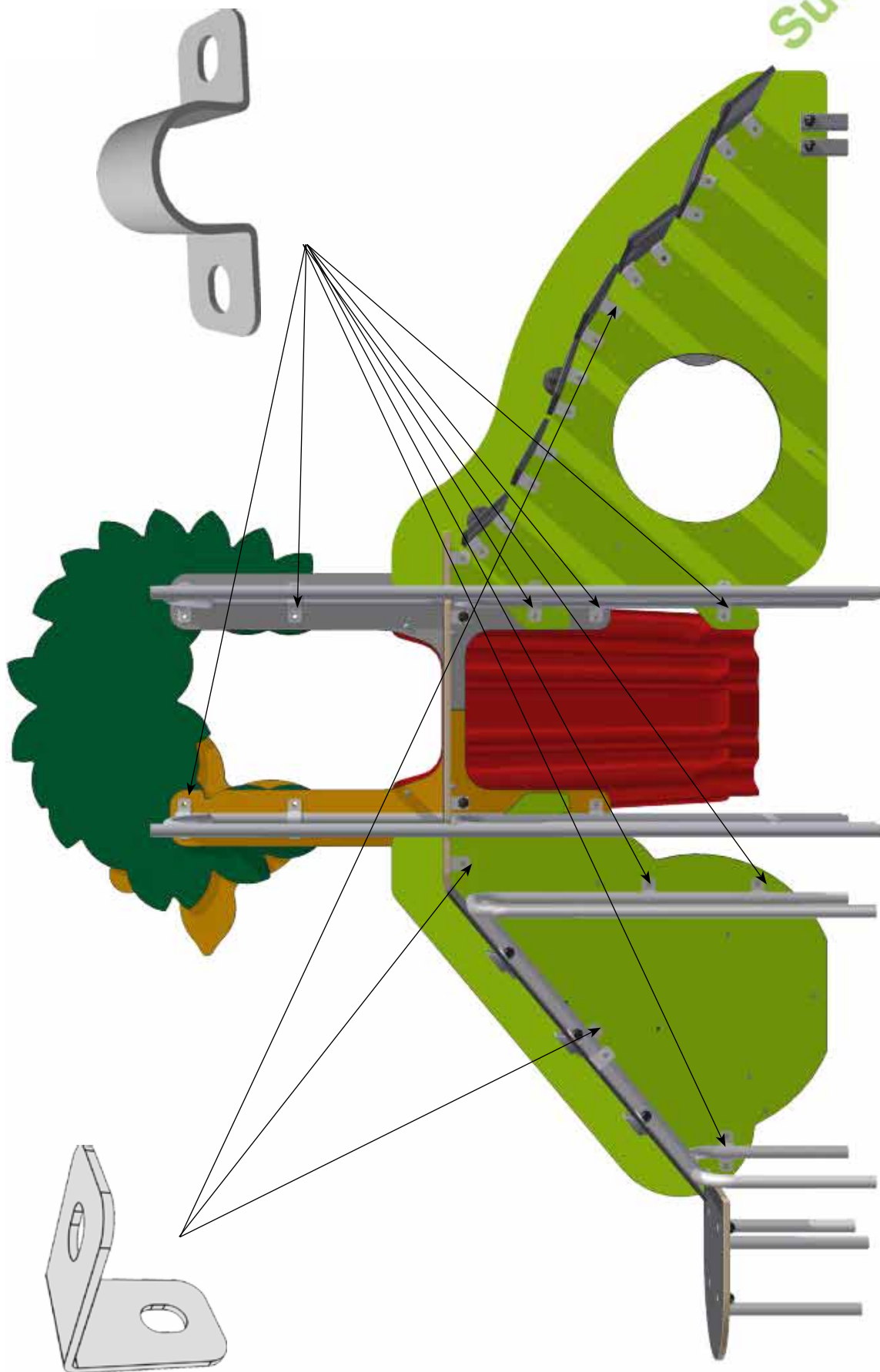

THU005

Themed Unit Bracket Assembly

design
make
play
SutcliffePlay

Nautilus Side

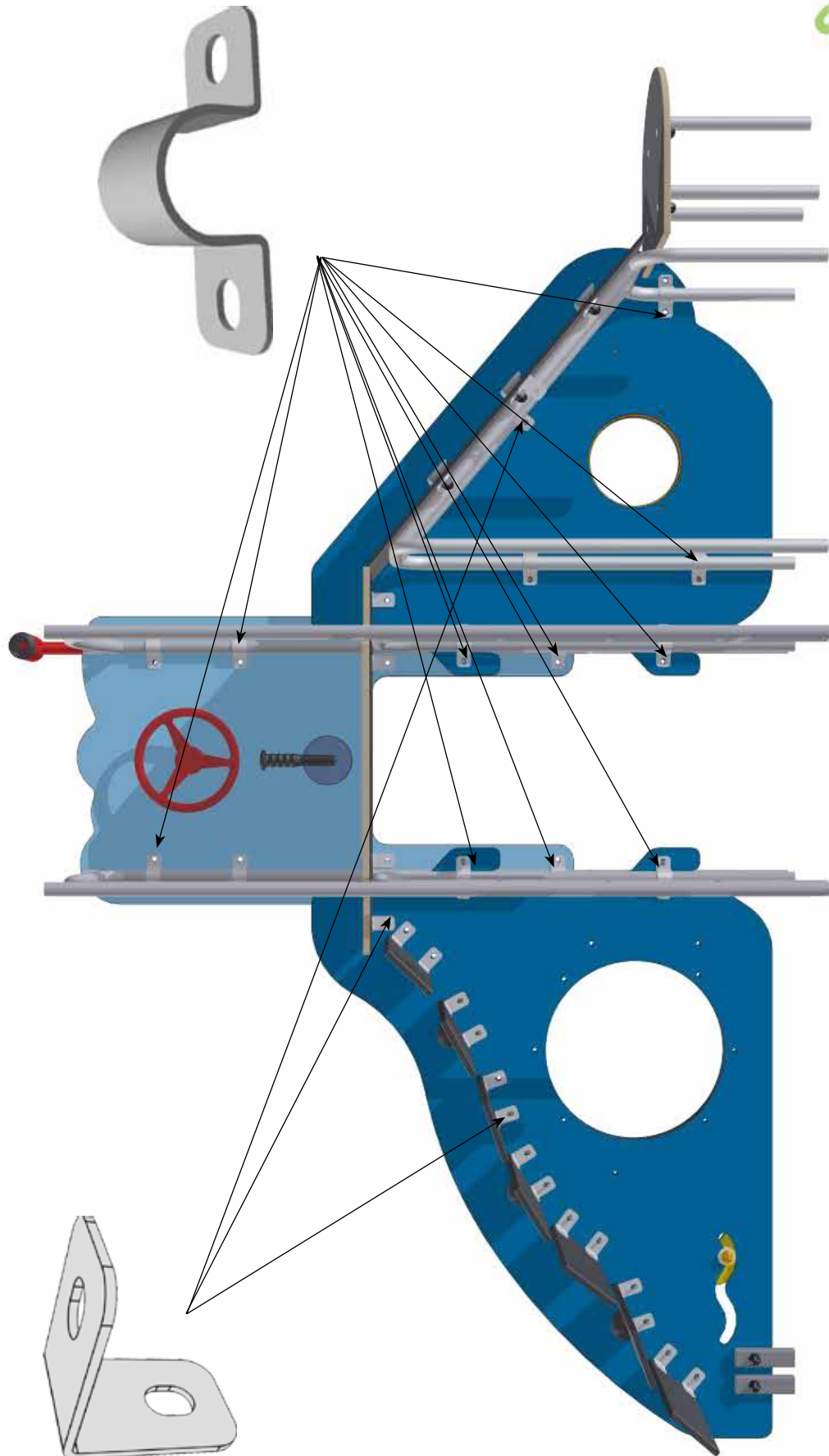

THU005

Themed Unit
Slide Assembly

design
make
play
SutcliffePlay



PSL250R
Slide Bracket



PSL260R
Plastic Slide
1.2m High

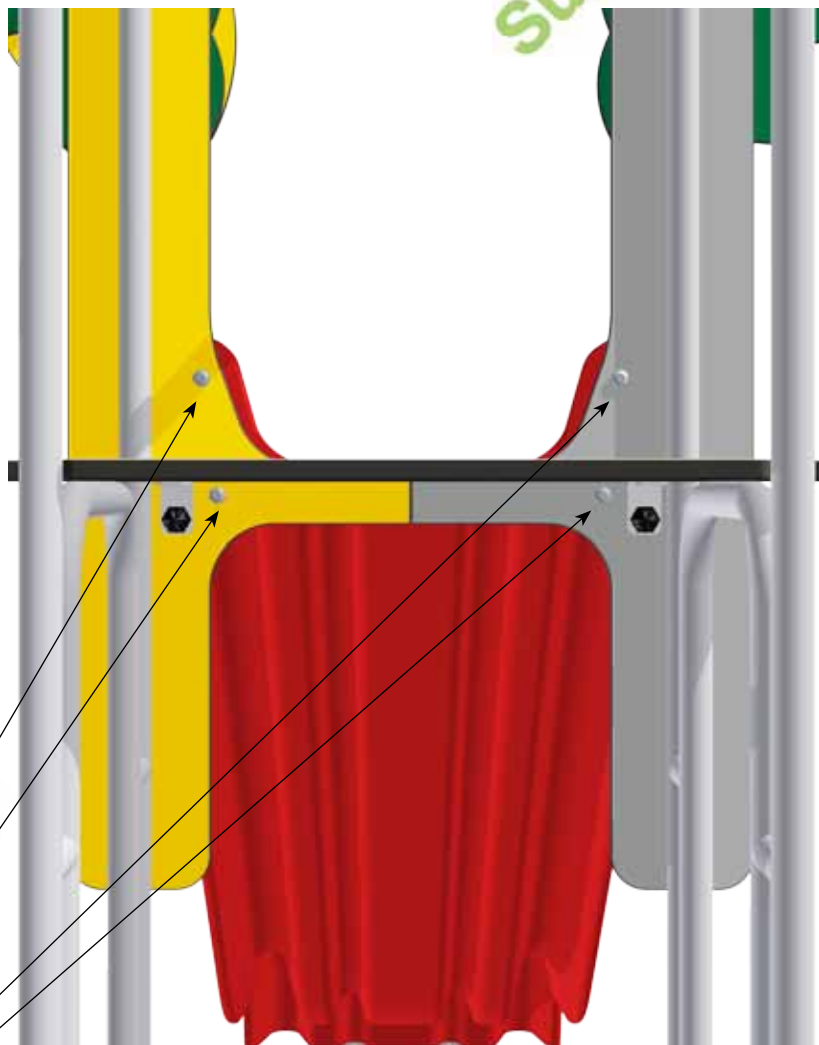

FIX155P
(M10 x 30 Patch-locked
security bolt)

+



WSR040
(M10 plain washer)

FIX150
(M10 x 20
security bolt)

+

WSR040
(M10 plain washer)

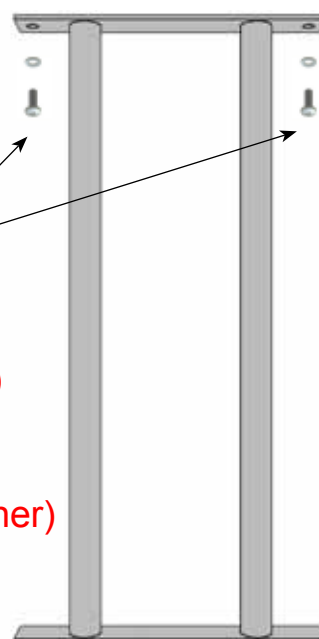

ORS056
Plastic Slide Pedestal

THU005

Themed Unit
Lever Assembly

design
make
play
SutcliffePlay

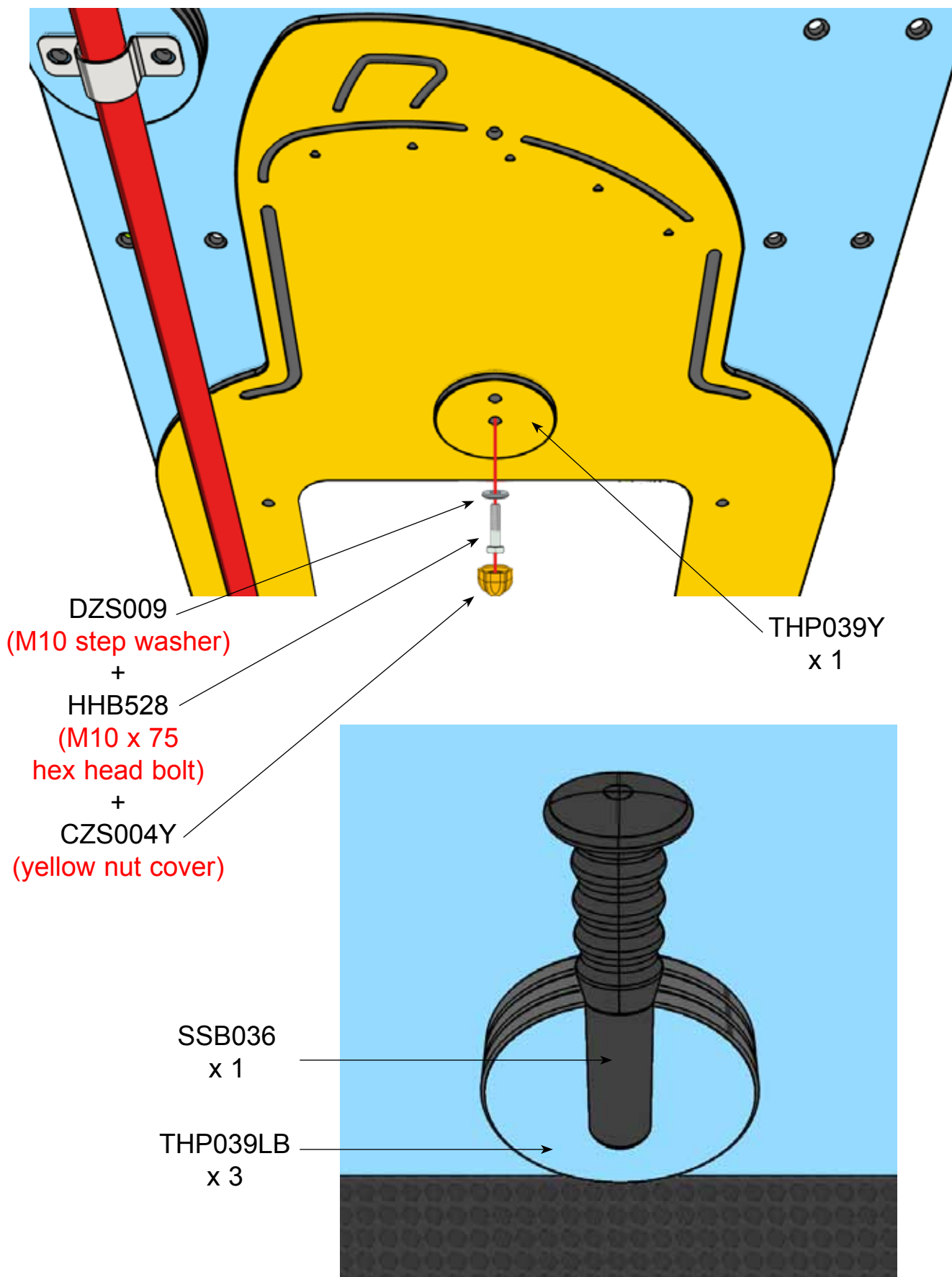

THU005

Themed Unit Maintenance Instructions

NB: The warranty is invalidated if these instructions are not followed.
All wood needs annual inspection and retreatment where required.

Recommended Regular Inspection and Maintenance

| | Interval Days | | | | |
|---|--------------------------|-------------------------------------|-------------------------------------|-------------------------------------|-------------------------------------|
| | 7 | 14 | 28 | 56 | 365 |
| Check stability of structure, tighten connections if required. | <input type="checkbox"/> | <input type="checkbox"/> | <input type="checkbox"/> | <input checked="" type="checkbox"/> | <input type="checkbox"/> |
| Check all uprights at ground level for corrosion and/or rot. Replace any defective parts. | <input type="checkbox"/> | <input type="checkbox"/> | <input type="checkbox"/> | <input type="checkbox"/> | <input checked="" type="checkbox"/> |
| Check all painted elements for damage, rub down and repaint or replace as required. | <input type="checkbox"/> | <input type="checkbox"/> | <input type="checkbox"/> | <input checked="" type="checkbox"/> | <input type="checkbox"/> |
| Check chain/ropework assemblies for wear and damage, replace if required. | <input type="checkbox"/> | <input checked="" type="checkbox"/> | <input type="checkbox"/> | <input type="checkbox"/> | <input type="checkbox"/> |
| Check rotating and pivot points for wear and smooth running, lubricate or replace if required. | <input type="checkbox"/> | <input type="checkbox"/> | <input checked="" type="checkbox"/> | <input type="checkbox"/> | <input type="checkbox"/> |
| Check rubber parts for wear and/or damage, replace if required. | <input type="checkbox"/> | <input type="checkbox"/> | <input checked="" type="checkbox"/> | <input type="checkbox"/> | <input type="checkbox"/> |
| Check tension cables, adjust if required. | <input type="checkbox"/> | <input type="checkbox"/> | <input checked="" type="checkbox"/> | <input type="checkbox"/> | <input type="checkbox"/> |
| Check wear of cables, replace if required. | <input type="checkbox"/> | <input type="checkbox"/> | <input checked="" type="checkbox"/> | <input type="checkbox"/> | <input type="checkbox"/> |
| Check slide chutes for smoothness and any foreign elements, remove any found. | <input type="checkbox"/> | <input type="checkbox"/> | <input checked="" type="checkbox"/> | <input type="checkbox"/> | <input type="checkbox"/> |
| Check rubber safety surfaces for damage and poor performance, repair or replace if required. | <input type="checkbox"/> | <input type="checkbox"/> | <input type="checkbox"/> | <input checked="" type="checkbox"/> | <input type="checkbox"/> |
| Check loose fill safety surfaces, remove any foreign elements, rake level and top up if required. | <input type="checkbox"/> | <input type="checkbox"/> | <input checked="" type="checkbox"/> | <input type="checkbox"/> | <input type="checkbox"/> |

Disposal Instructions

All components should be broken down into categories of:-

- 1 **Mild Steel** - all 38mm Ø tube, step/ring climbers, welded bar, swing frames, deck frames, springie frames.
- 2 **Stainless Steel** - all slides, mirror panels.
- 3 **Aluminium** - all Playzone, Mission and Toddlerzone posts.
- 4 **Galvanised Steel** - all chains and Teenzone posts.
- 5 **Moulded Rubber Products without steel inserts** - all Mission and Toddlerzone Caps and edge details.
- 6 **Timber** - all natural timber, plywood, and MDF panels.

Wherever possible these materials should be taken to specialist recycling organisations and recycled.
In some cases where composite materials are used, then disposal at land fill sites is the only alternative such as:

- 7 **Moulded Rubber Products encasing steel inserts** - all Swing Seats, Deck Tops, Duo/Dizzy Disc Tops.
- 8 **High Pressure Laminate** - all Toddlerzone, Playzone, Minizone, Teenzone and Themed panels.
- 9 **Steel Core Polypropylene Rope** - all Scramble Nets, Space Nets, Playzone/Toddlerzone/Mission Ropes.