

**Good design  
for children**

**SutcliffePlay**

**Waggon Lane  
Upton Pontefract  
West Yorkshire WF9 1JS  
Telephone +44 (0)1977 653200  
Facsimile +44 (0)1977 653222  
info@ sutcliffeplay.co.uk  
www. sutcliffeplay.co.uk**

# **Aktivzone**

**Installation Instructions**

## **XZU300**

# XZU300

## Aktivzone Unit Installation Instructions

Good design  
for children  
**SutcliffePlay**

1. Read all instructions carefully before starting assembly.
2. Check using the parts list and fixing kit list that none of the components are missing. If any parts are missing contact our sales office.
3. Plan the final position of the play equipment ensuring there is sufficient space. See ground plan for recommended safety surface area and critical fall height to EN-1176.
4. Excavate the foundation holes in accordance with the ground plan. Aktivzone is designed to be installed onto a level site.
5. Erect the main posts into the foundation holes. Each leg is numbered 1 to 17 to correspond with the ground plan. Follow the assembly sequence sheet to erect each post in the correct sequence.
6. Ensure each upright is fitted with two spragging irons.
7. Each joint is lettered A to R, see post connection sheet. It is important to ensure that each joint is fully seated in the cutout and tightened fully. The main connections are secured with M16 bolts, two 24mm socket drives are required.
8. Assemble the activities onto the posts in accordance with the assembly sheets.
9. Fill the foundation holes to the required depth with concrete.
10. Do not allow the equipment to be used until the concrete has set (2-3 days) and the required safety surface has been installed.
11. Check that all fixing bolts are fully tightened. Glue in the rubber bolt covers as described on the assembly sheet.
12. Follow the maintenance instructions supplied.









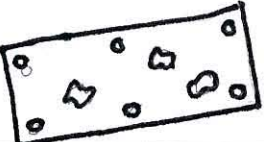
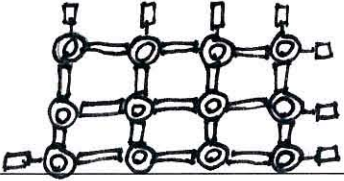

During installation care must be taken to prevent hazards to children.  
Care should be taken if conditions are abnormal.

Installation of this type of equipment requires at least three people,  
and the use of a lifting tower or platform.

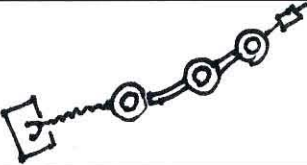



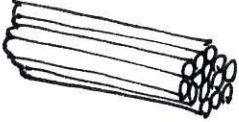







### Tools Required

M10 Security screw fixing tool ref FIX195  
Socket for M16 bolt x 2  
Socket for M10 bolt  
Set of Allen Keys  
Digging Implements

# Aktivzone XZU300 Parts List

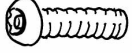
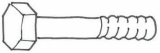
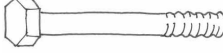
Illustration	Code	Description	Quantity
	XZA012	Climbing Wall Outer Rail	4
	XZA014	Climbing Wall Middle Rail	6
	XZA017	Climbing Wall Post Plate	12
	XZA021	Climbing Wall Panel	8
	XZA100	Flexi-Net	1
	XZA030	Hanging Ring	5
	XZA035	Flexihold	2
	XZA040	Flexi ring climber	1
	XZA060	Firemans Pole	1
	XZA065	Rigid Hold	6
	XZA074	V Seat Rubber Top	2
	XZA078	V Seat Support Bar	4
	XZP300	Set of 17 Posts	1 Set
	XZS035	Post Cap	20
	XZU300F	Set of Fixings	1 Set

# Aktivzone XZU300F Fixing Kit List

	Code	Description	Qty		Code	Description	Qty
	DZS005	M10 Nut Cover	52				
	DZS009	M10 Cover Washer	52				
	LKN320	M10 Nylock Nut	52				
	MCS321	M10 x 35mm Long Countersunk Socket	4				
	MSL003	Spragging Iron 300mm Long	36				
	PLN340	M16 Plain Nut	55				
	FIX195	Security Screw Fixing Tool	1				
	WSR430	M12 Large Washer	48				
	FIX155	M10 x 30mm Long Security Screw	52				
	FIX159	M10 x 40mm Long Security Screw	36				
	HHB700	M16 x 100mm Long hex Head Bolt	38				
	HHB740	M16 x 170mm Long hex Head Bolt	18				
	LKN350	M16 Locking Nut	18				
	XZS013	Rubber Moulded Cap	129				
	XZS012	Rubber Moulded Sleeve	156				
	ADH150	Adhesive	1				

# Aktivzone XZU300 Post Assembly Sequence

Good design  
for children

SutcliffePlay

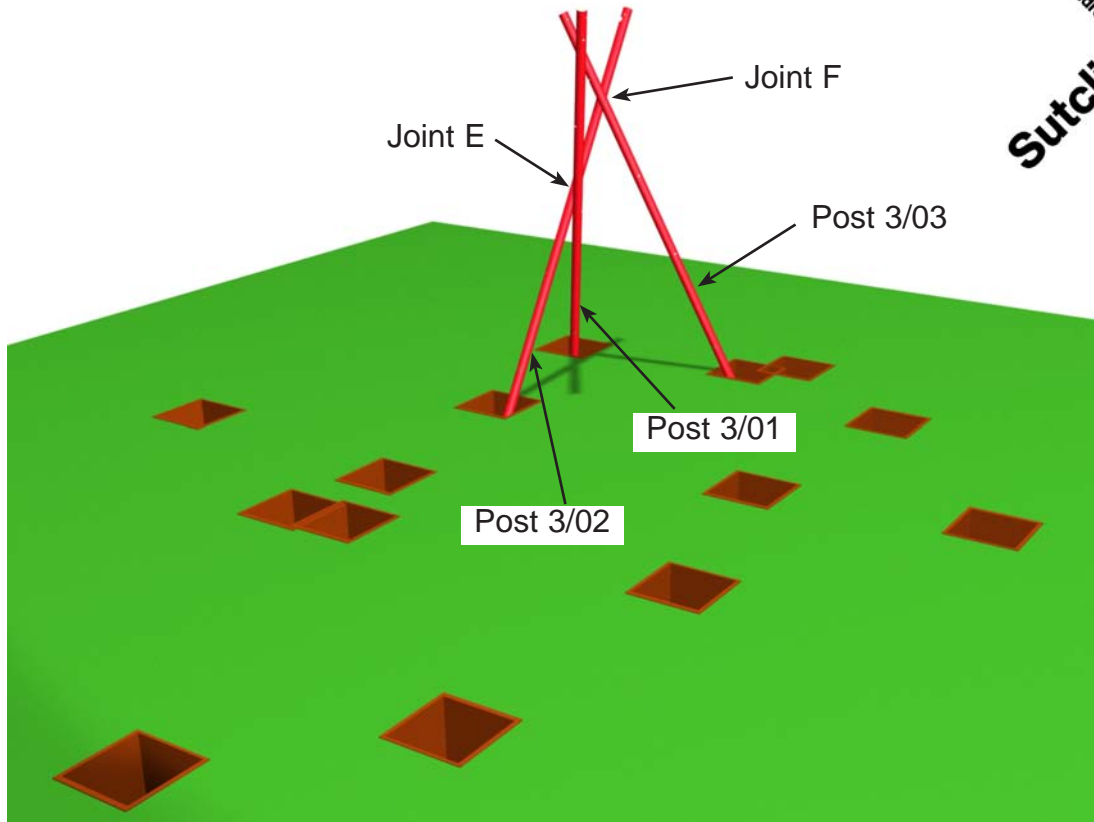

1

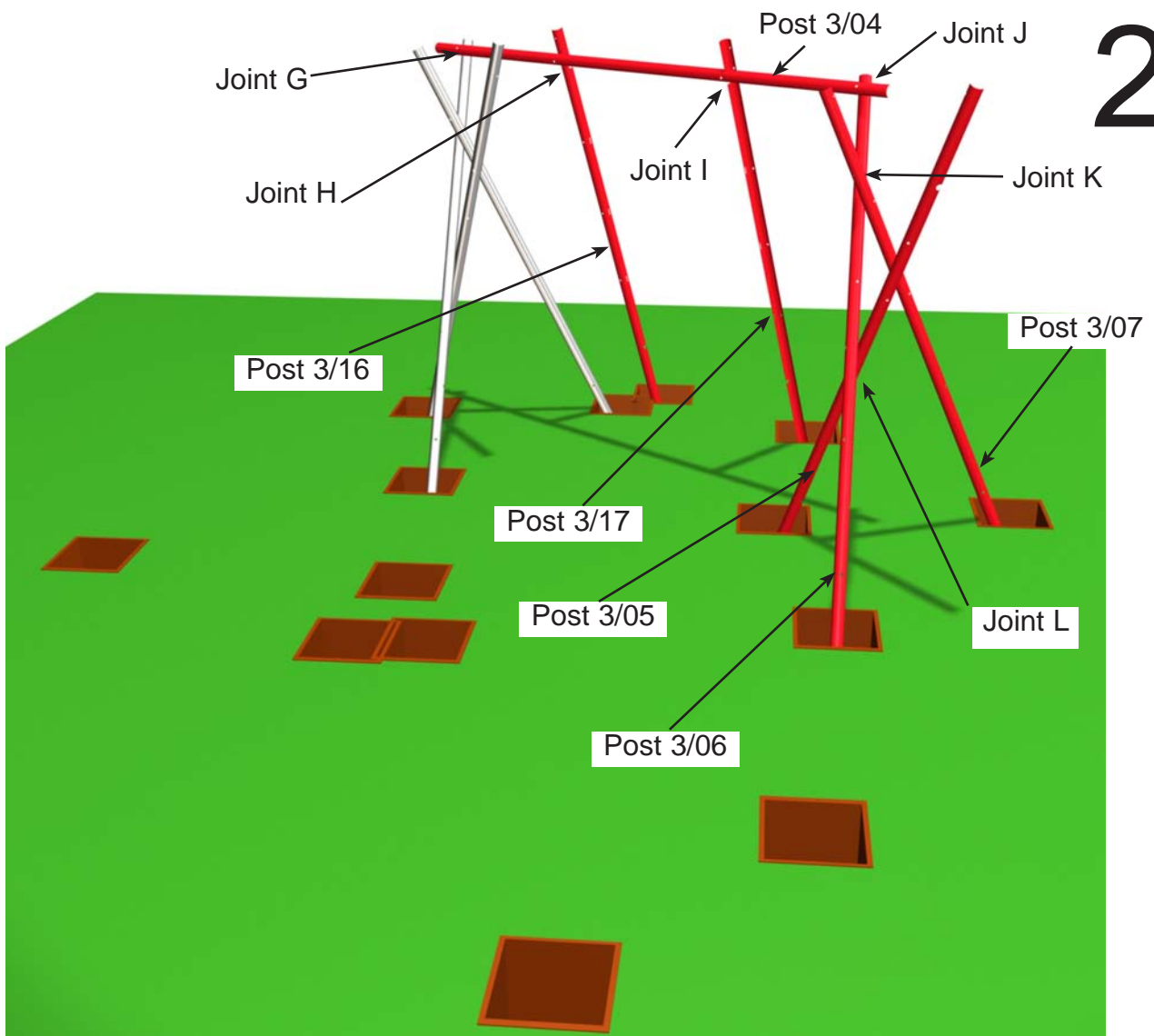

2



# Aktivzone XZU300 Post Assembly Sequence

Good design  
for children

**SutcliffePlay**

# 3

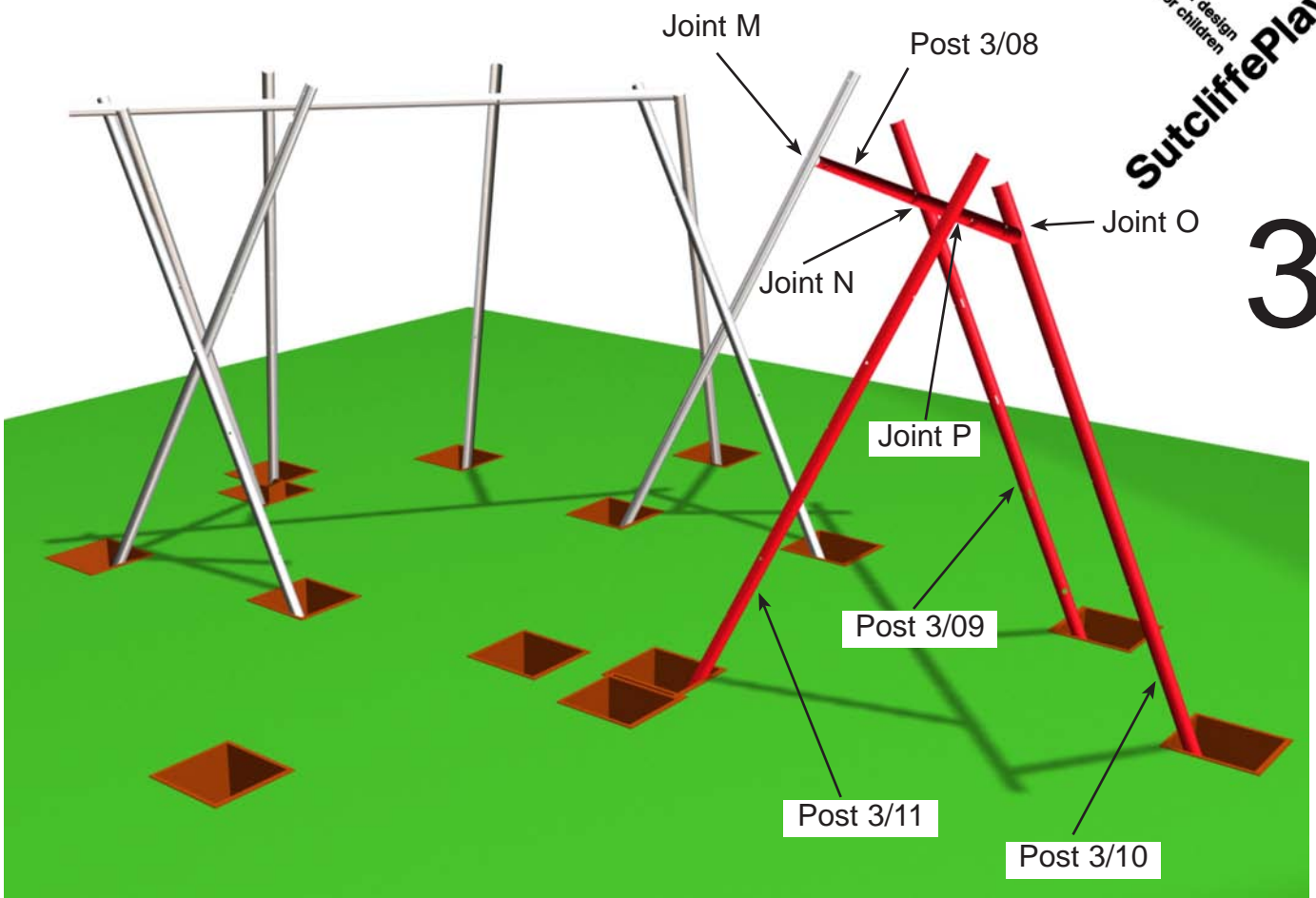

# 4

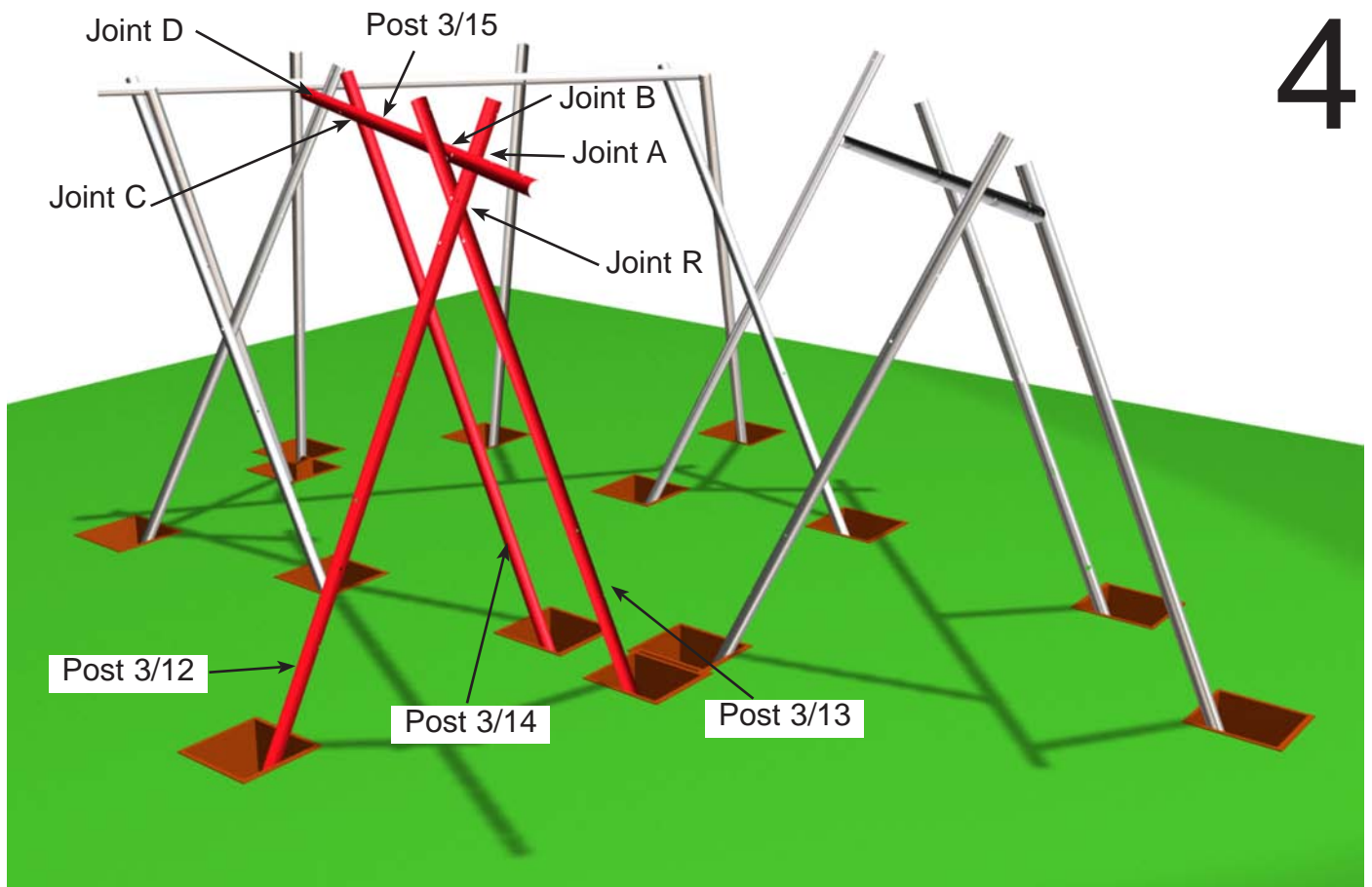

# Aktivzone Post Connection

Good design  
for children  
**SutcliffePlay**

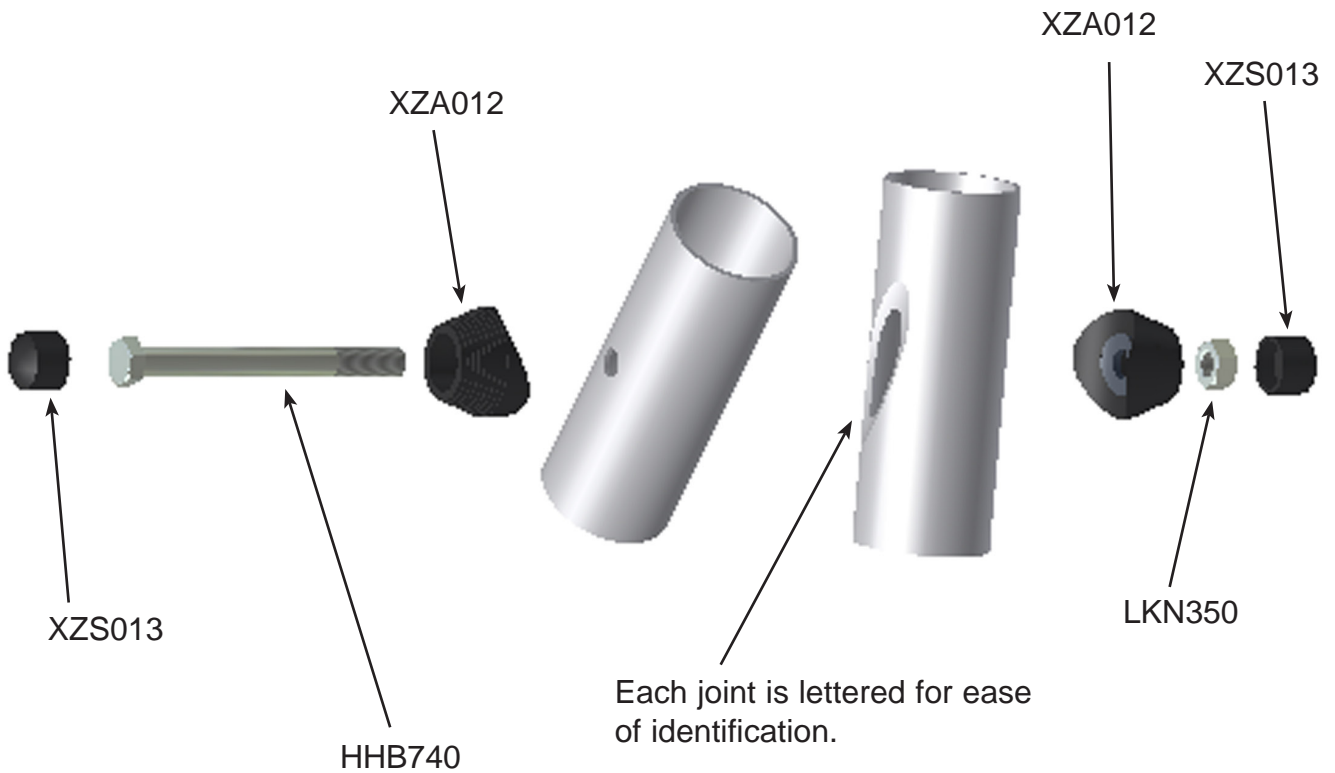

Ensure all joints are fully seated in the cutouts and tightened fully.

Ref	Description	Qty Per Joint
XZS012	Moulded Sleeve	2
HHB740	M16 x 170 Hex Head Bolt	1
LKN350	M16 Locking Nut	1
XZS013	Moulded Cap	2

(Moulded cap to be glued in position after final bolt tightening)

# XZU300

## Aktivzone Unit

Good design  
for children

SutcliffePlay

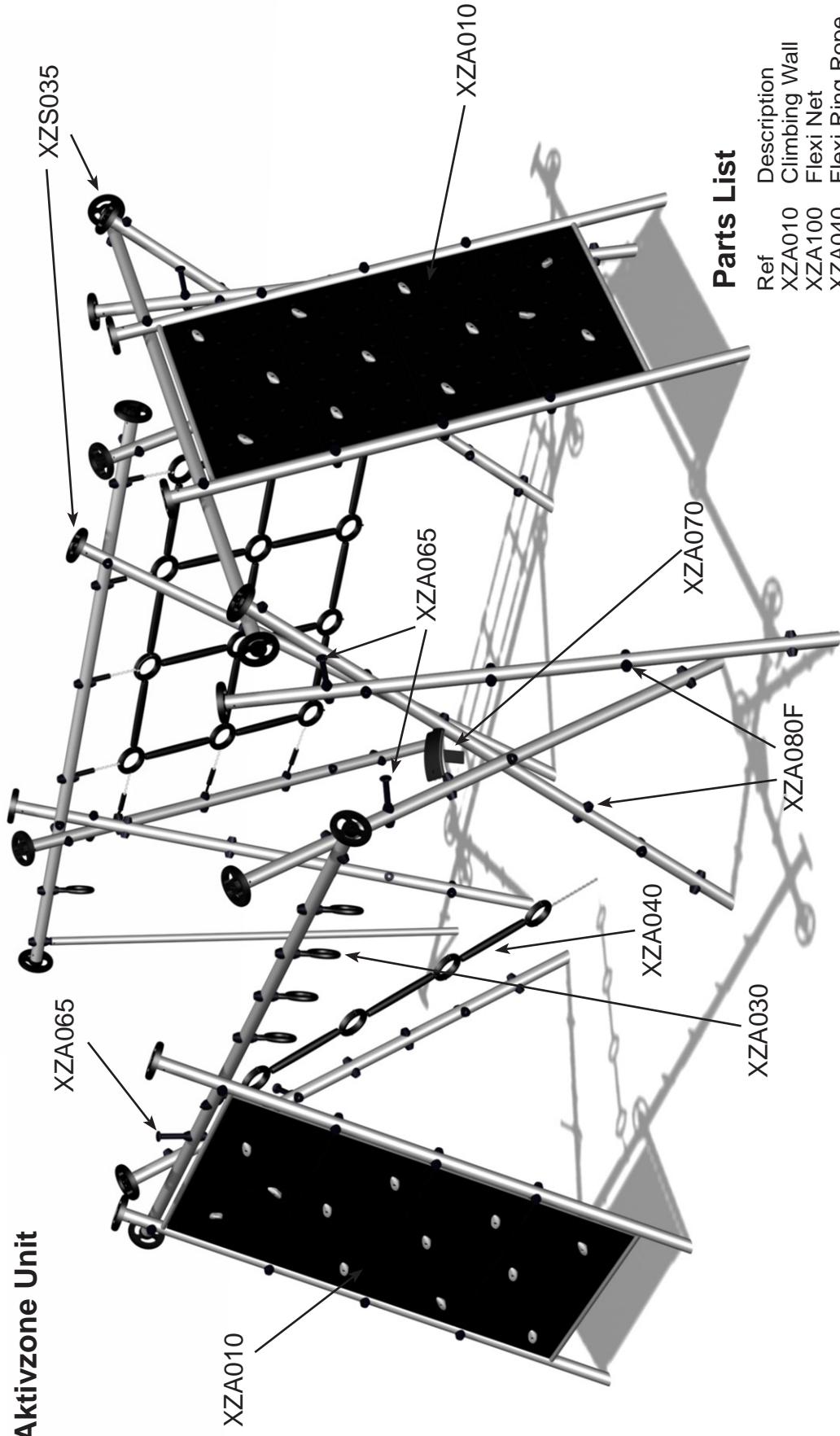

### Parts List

Ref	Description	Qty
XZA010	Climbing Wall	2
XZA100	Flexi Net	1
XZA040	Flexi Ring Rope	1
XZA070	V Seat	2
XZA035	Flexi Hold	2
XZA060	Firemans Pole	1
XZA065	Rigid Hold	6
XZS035	Post Cap	20
XZA030	Hanging Ring	5
XZA080F	Bolt Hold	21
XZP300	Posts (Set of 17)	1 Set
XZU300F	Fixing Kit	1 Set



# XZU300

Aktivzone Unit

SutcliffePlay  
Good design  
for children

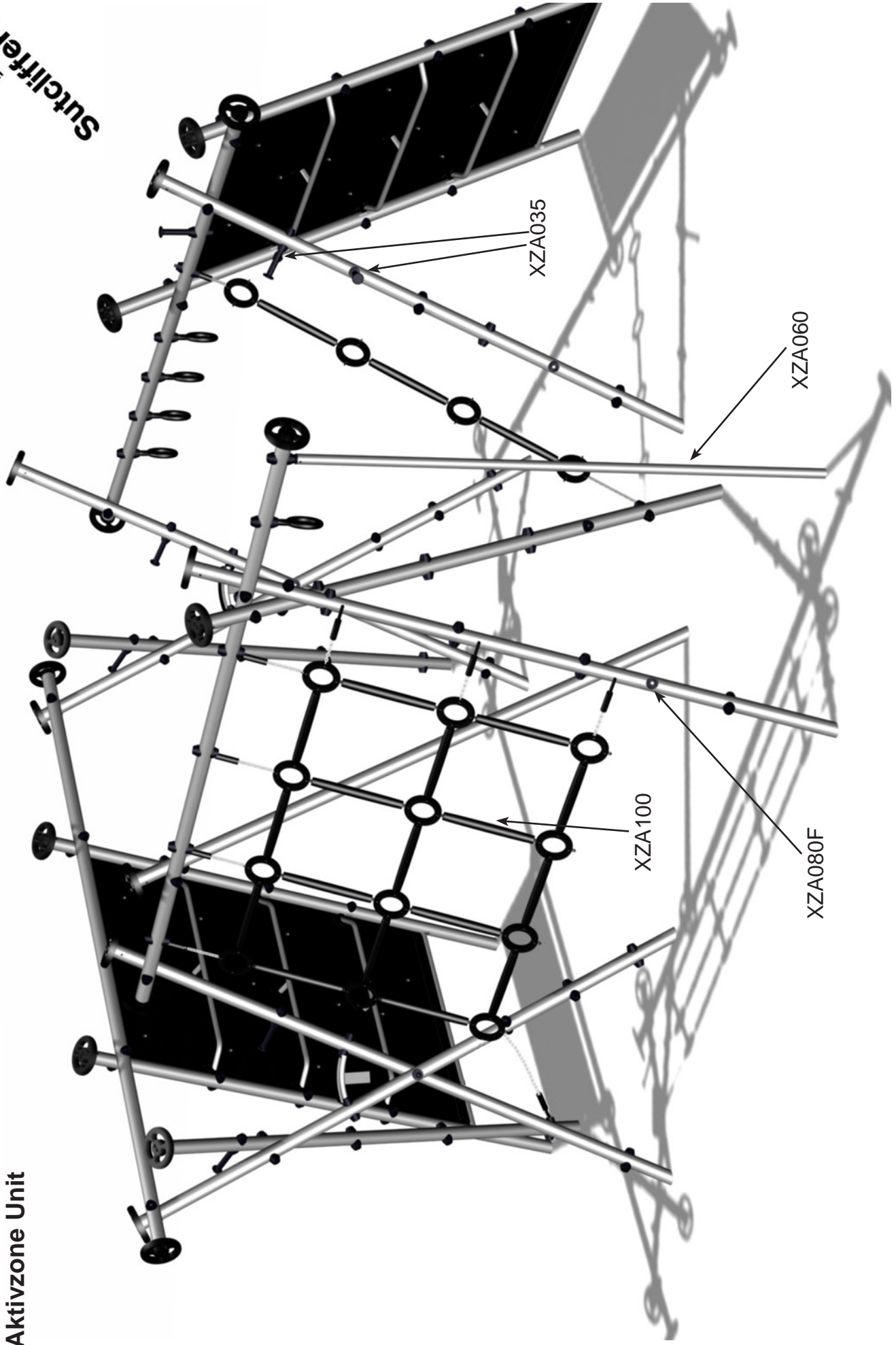

# XZU300

Aktivzone Unit

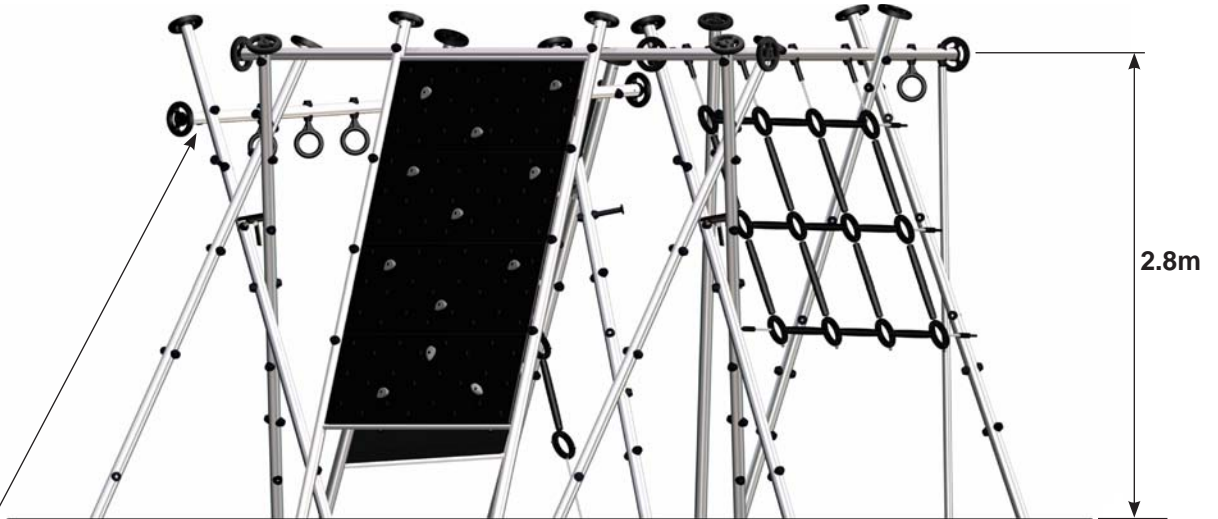

Please note that  
this top bar is not  
horizontal to the  
play level

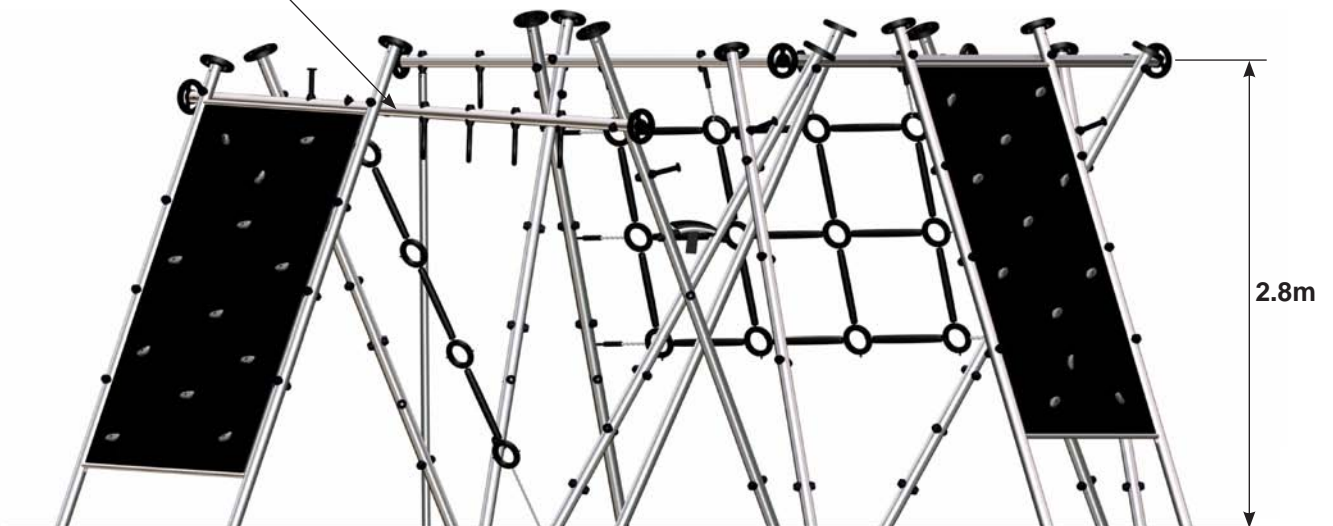

# XZA010

## Aktivzone Climbing Wall

Good design  
for children

**SutcliffePlay**

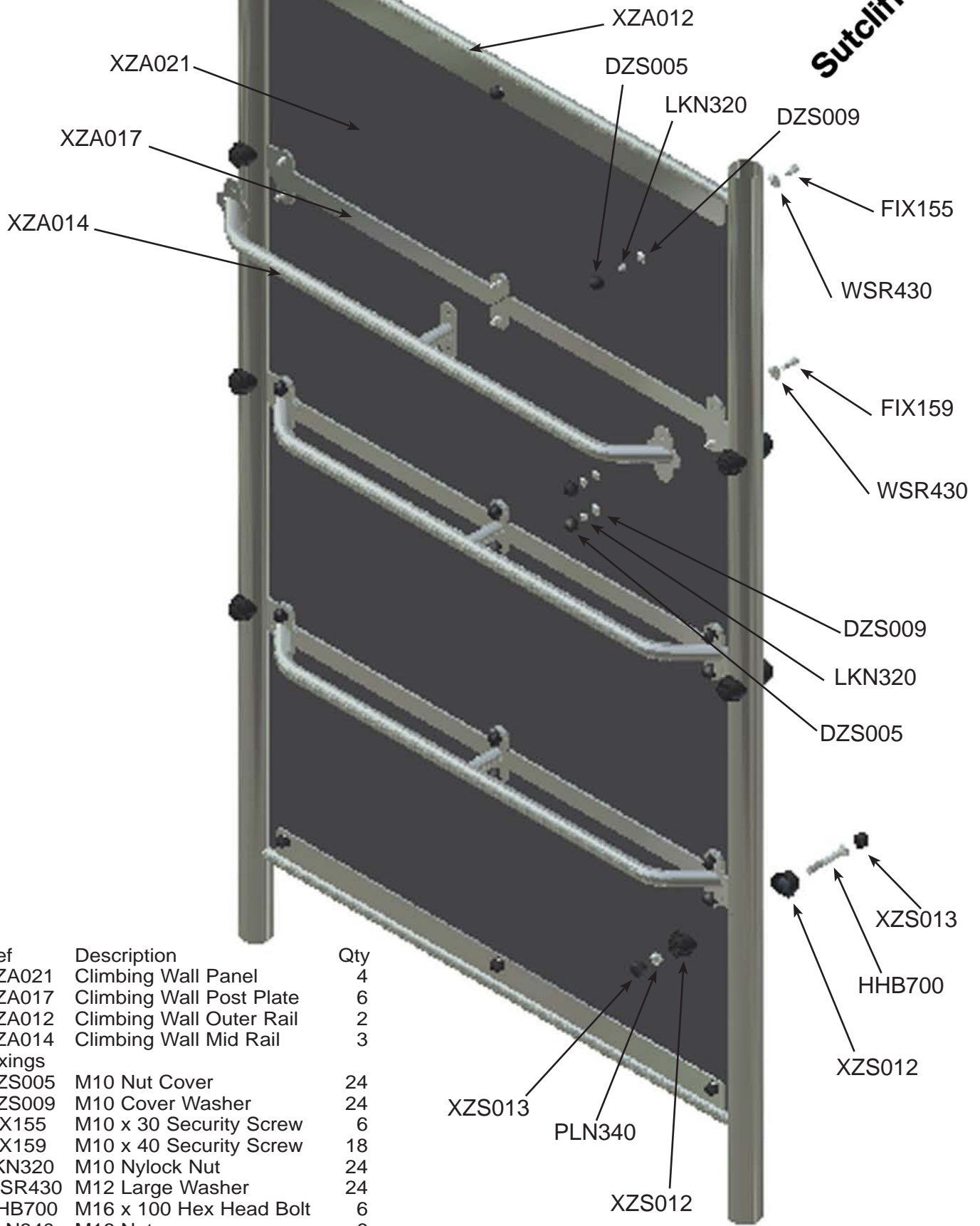

Ref	Description	Qty
XZA021	Climbing Wall Panel	4
XZA017	Climbing Wall Post Plate	6
XZA012	Climbing Wall Outer Rail	2
XZA014	Climbing Wall Mid Rail	3
<b>Fixings</b>		
DZS005	M10 Nut Cover	24
DZS009	M10 Cover Washer	24
FIX155	M10 x 30 Security Screw	6
FIX159	M10 x 40 Security Screw	18
LKN320	M10 Nylock Nut	24
WSR430	M12 Large Washer	24
HHB700	M16 x 100 Hex Head Bolt	6
PLN340	M16 Nut	6
XZS012	Moulded Sleeve	12
XZS013	Moulded Cap	12
(Moulded cap to be glued in position after final bolt tightening)		

# XZA100

Aktivzone Flexi Net

Good design  
for children

**SutcliffePlay**

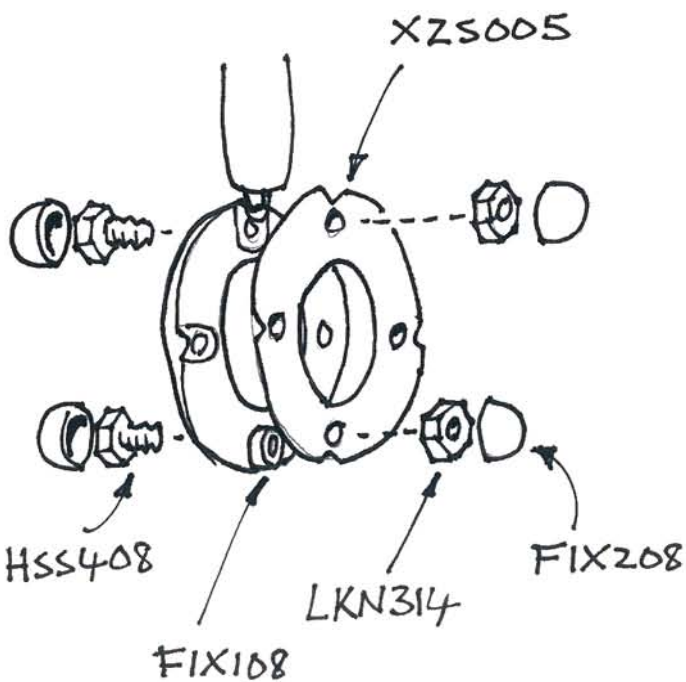
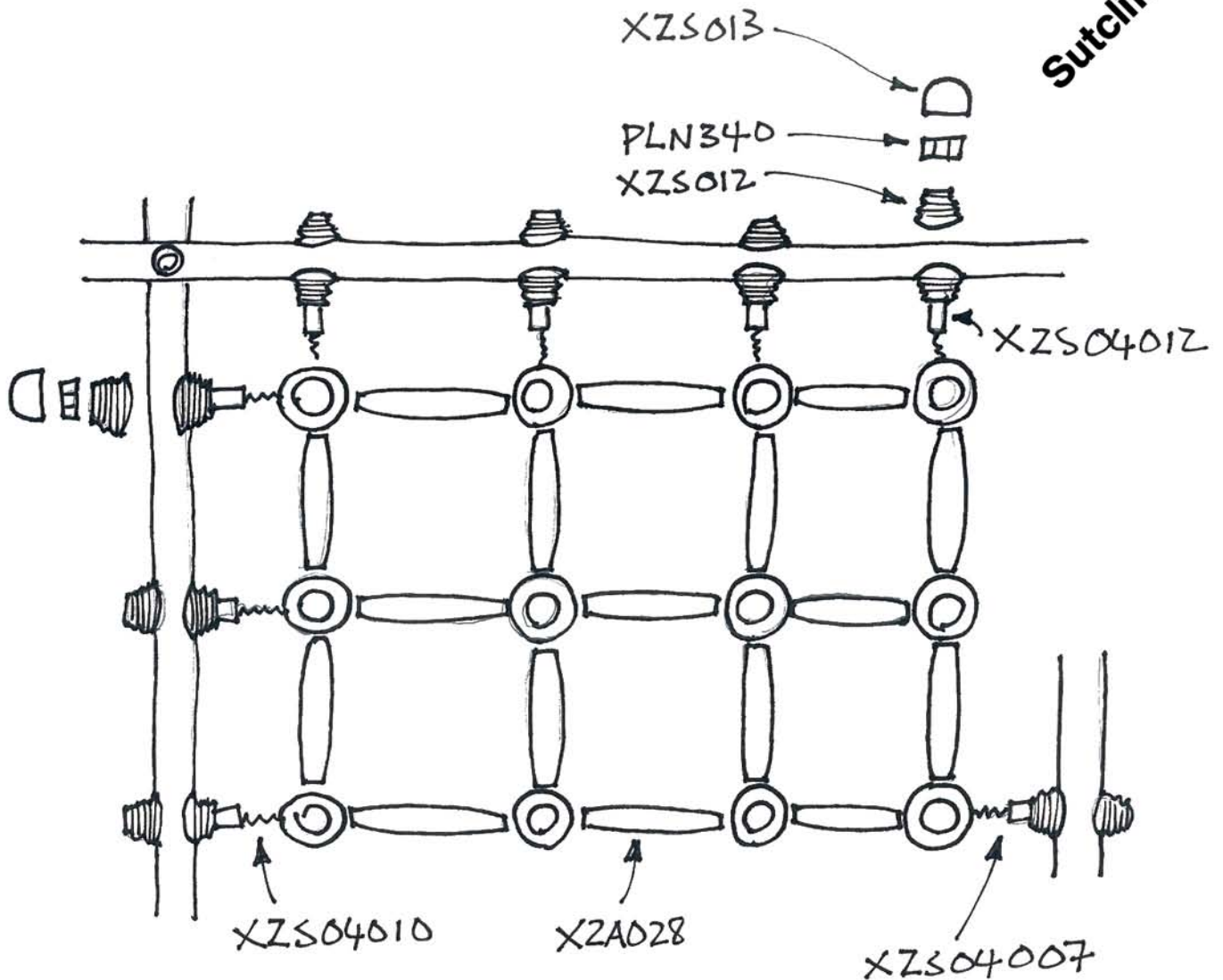

Ref	Description	Qty
XZA100	Flexi Net Full Assembly	1
Parts		
XZS005	Handring Half Moulding	24
XZA028	Flexi Chain Assembly	17
XZS04007	Post Chain 7 Links	1
XZS04010	Post Chain 10 Links	3
XZS04012	Post Chain 12 Links	4
Fixings		
HSS408	M8 x 25 Hex Head Screw	48
LKN314	M8 Lock Nut	48
FIX208	M8 Nut Cover	96
FIX108	5mm Nylon Spacer	6
PLN340	M16 Nut	8
XZS012	Moulded Sleeve	16
XZS013	Moulded Cap	8

(Moulded cap to be glued in position after final bolt tightening)



# XZA030

Aktivzone Hanging Ring

Good design  
for children  
**SutcliffePlay**



Ref	Description	Qty
XZA030	Hanging Ring	1
Fixings		
PLN340	M16 Nut	1
XZS012	Moulded Sleeve	2
XZS013	Moulded Cap	1
(Moulded cap to be glued in position after final bolt tightening)		



# XZA035

Aktivzone Flexi Hold

Good design  
for children  
**SutcliffePlay**



Ref	Description	Qty
XZA035	Flexi Hold	1
Fixings		
PLN340	M16 Nut	1
XZS012	Moulded Sleeve	2
XZS013	Moulded Cap	1
(Moulded cap to be glued in position after final bolt tightening)		

# XZA040

## Aktivzone Flexi Ring Rope

Good design  
for children

**SutcliffePlay**

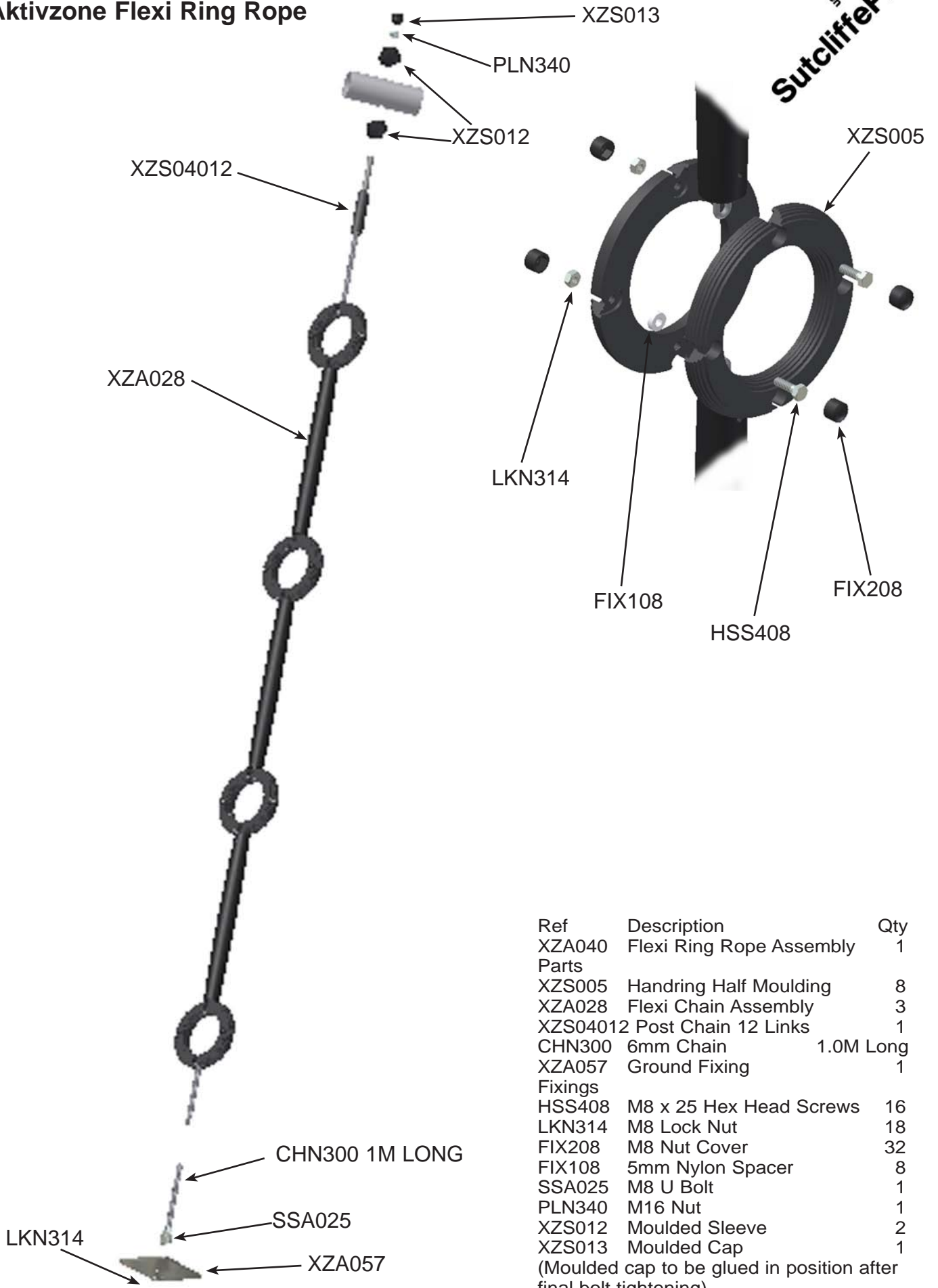

Ref	Description	Qty
XZA040	Flexi Ring Rope Assembly	1
Parts		
XZS005	Handring Half Moulding	8
XZA028	Flexi Chain Assembly	3
XZS04012	Post Chain 12 Links	1
CHN300	6mm Chain	1.0M Long
XZA057	Ground Fixing	1
Fixings		
HSS408	M8 x 25 Hex Head Screws	16
LKN314	M8 Lock Nut	18
FIX208	M8 Nut Cover	32
FIX108	5mm Nylon Spacer	8
SSA025	M8 U Bolt	1
PLN340	M16 Nut	1
XZS012	Moulded Sleeve	2
XZS013	Moulded Cap	1
(Moulded cap to be glued in position after final bolt tightening)		

CHN300 1M LONG

SSA025

LKN314

XZA057

# XZA060

Aktivzone Firemans Pole

Good design  
for children  
**SutcliffePlay**

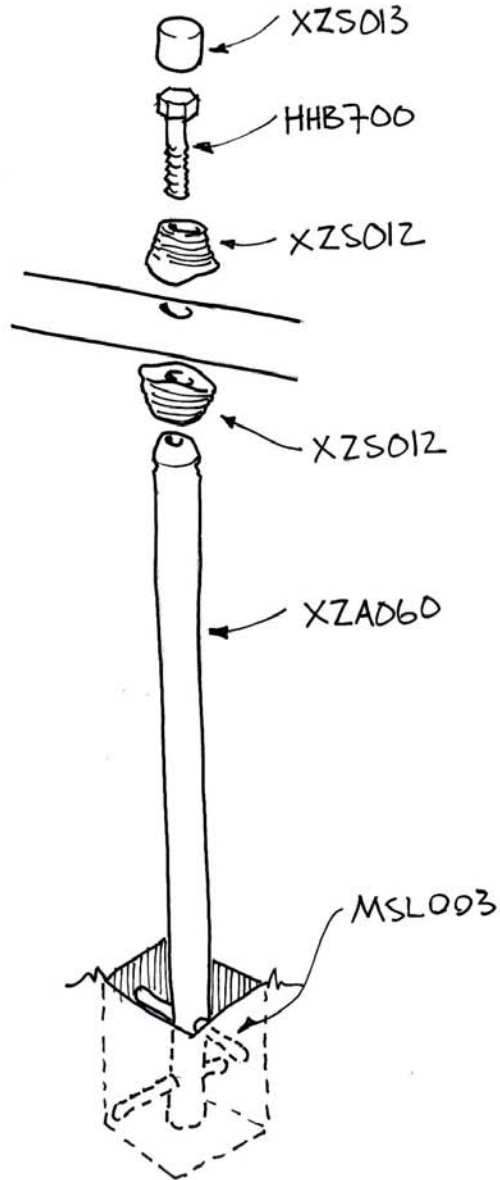

Ref	Description	Qty
XZA060	Firemans Pole	1
	Fixings	
MSL003	Spragging Irons	2
HHB700	M16 x 100 Hex Head Bolt	1
XZS012	Moulded Sleeve	2
XZS013	Moulded Cap	1
	(Moulded cap to be glued in position after final bolt tightening)	

# XZA065

Aktivzone Rigid Hold

Good design  
for children  
**SutcliffePlay**



Ref	Description	Qty
XZA065	Rigid Hold	1
Fixings		
PLN340	M16 Nut	1
XZS012	Moulded Sleeve	2
XZS013	Moulded Cap	1
(Moulded cap to be glued in position after final bolt tightening)		

# XZA070

Aktivzone V Seat

Good design  
for children

**SutcliffePlay**

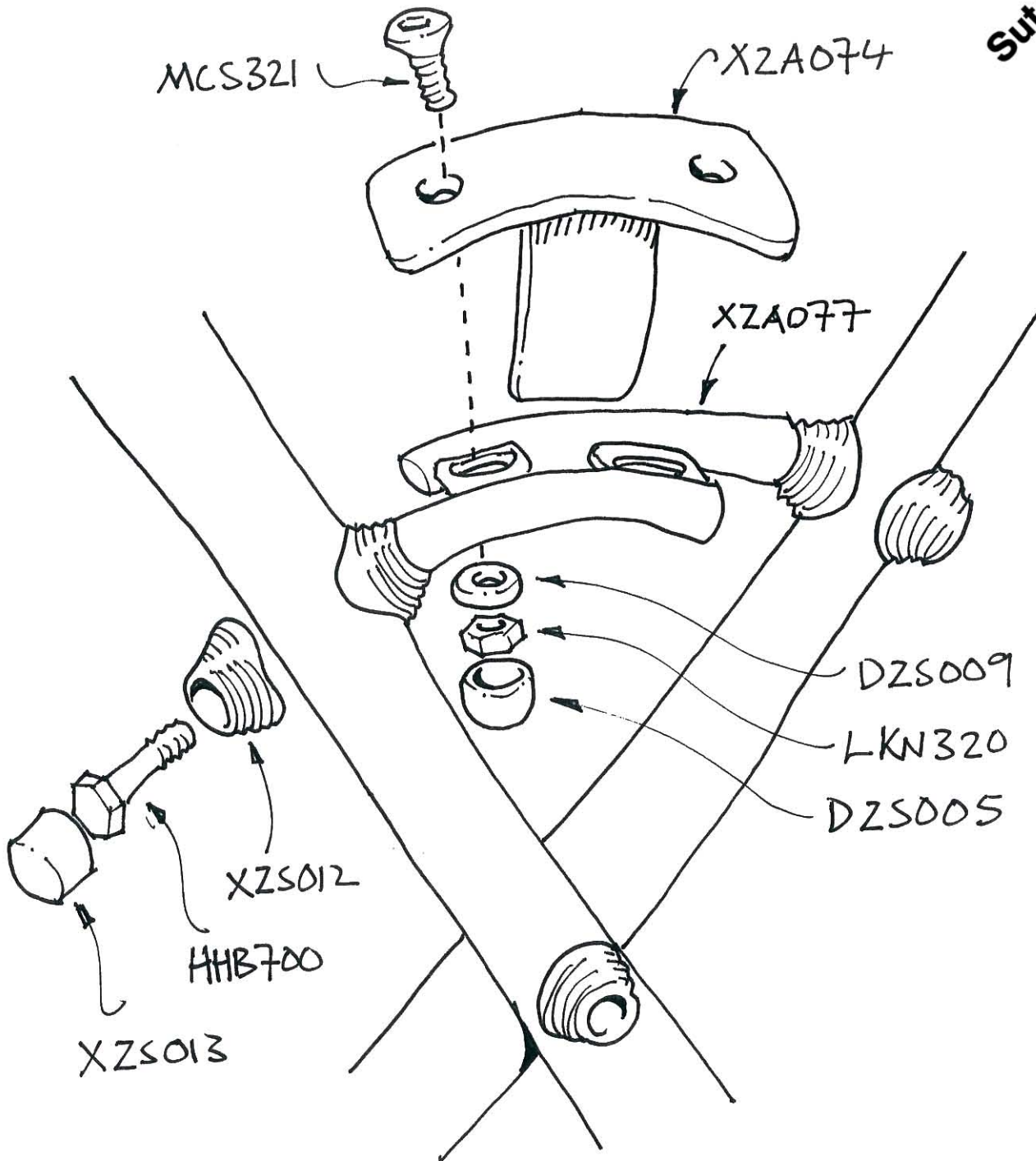

Ref	Description	Qty
XZA074	Rubber Seat	1
XZA077	Support Bar	2
Fixings		
MCS321	M10 x 35 Socket Head	2
LKN320	M10 Lock Nut	2
DZS009	M10 Cover Washer	2
DZS005	M10 Nut Cover	2
HHB700	M16 x 100 Hex Head Bolt	2
XZS012	Moulded Sleeve	4
XZS013	Moulded Cap	2
(Moulded cap to be glued in position after final bolt tightening)		



# XZA080F

Aktivzone Bolt Hold

Good design  
for children  
**SutcliffePlay**

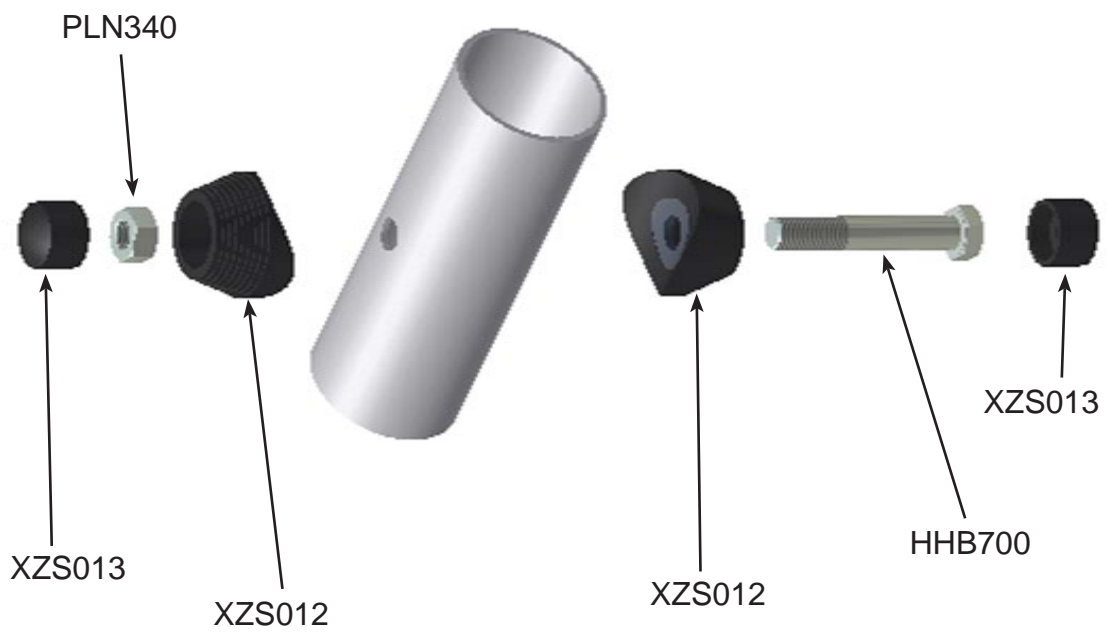

Ref	Description	Qty
HHB700	M16 x 100 Hex Head Bolt	1
PLN340	M16 Nut	1
XZS012	Moulded Sleeve	2
XZS013	Moulded Cap	2
(Moulded cap to be glued in position after final bolt tightening)		

# XZS035

Aktivzone Post Cap

Good design  
for children  
**SutcliffePlay**

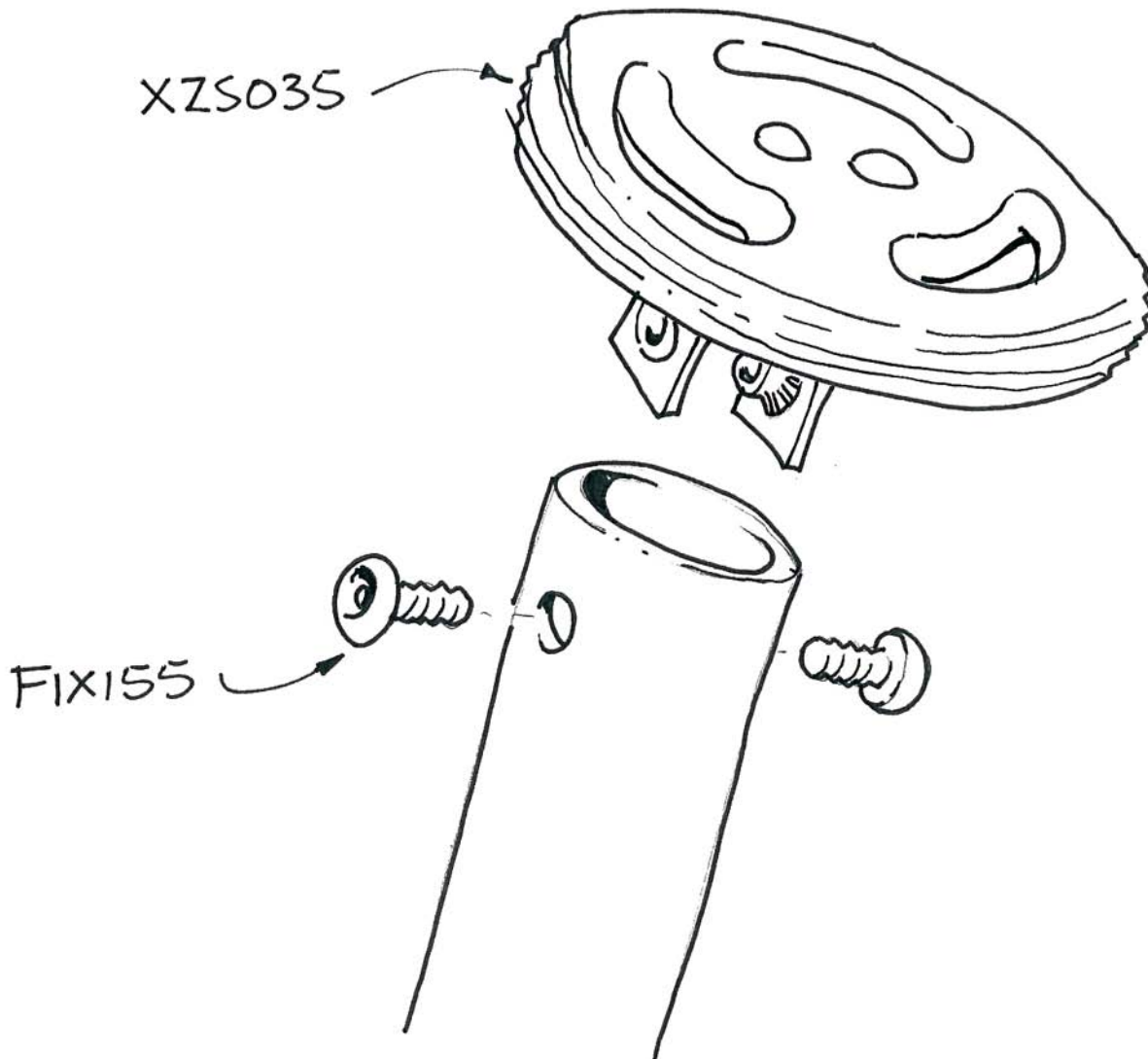

Ref	Description	Qty
XZS035	Post Cap	1
FIX155	M10 x 30 Security Screw	2

## Aktivzone Bolt Cover Assembly

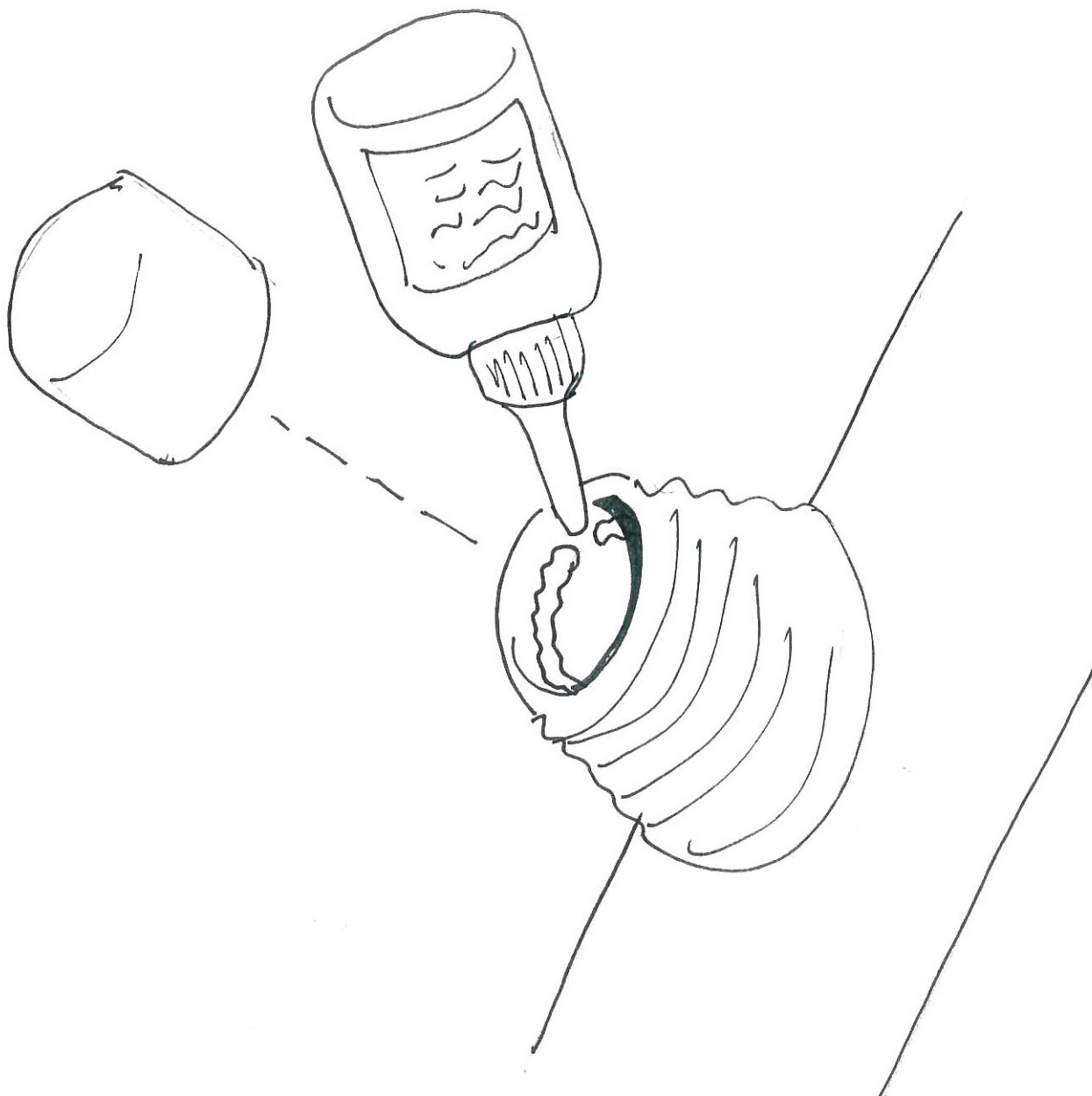

After final tightening of the fixing bolts, run a bead of glue around the inside of the rubber sleeve and insert the cap. Push the cap fully into the sleeve. Follow the safety precautions supplied with the adhesive.

Ref	Description	Qty
XZS013	Moulded Cap	1
ADH150	Adhesive	1

# XZU300

## Aktivzone Unit

### Maintenance Instructions

#### NOTE

The warranty is invalidated if these instructions are not followed.

All wood needs annual inspection and retreatment where required.

#### Recommended Regular Inspection and Maintenance

Check stability of structure, tighten connections if required.

Check all uprights at ground level for corrosion and/or rot. Replace any defective parts.

Check all painted elements for damage, rub down and repaint or replace as required.

Check chain/ropework assemblies for wear and damage, replace if required.

Check rotating and pivot points for wear and smooth running lubricate or replace if required.

Check rubber parts for wear and/or damage, replace if required.

Check tension cables, adjust if required.

Check wear of cables, replace if required.

Check slide chutes for smoothness and any foreign elements, remove any found.

Check rubber safety surfaces for damage and poor performance, repair or replace if required.

Check loose fill safety surfaces, remove any foreign elements,

#### Disposal Instructions

All components should be broken down into categories of:-

- 1 **Mild Steel** - all Swing Frames, Playzone, Toddlerzone, Teenzone activities, Deck Frames and Springie Frames.
- 2 **Stainless Steel** - all Slides, Mirror Panels.
- 3 **Aluminium** - all Playzone and Toddlerzone Posts.
- 4 **Galvanised Steel** - all Chains and Teenzone Posts.
- 5 **Moulded Rubber Products without steel inserts** - all Toddlerzone Caps and edge details.
- 6 **Timber** - all natural timber, plywood, and MDF panels.

Wherever possible these materials should be taken to specialist recycling organisations and recycled.

In some cases where composite materials are used, then disposal at land fill sites is the only alternative such as:

- 7 **Moulded Rubber Products encasing steel inserts** - all Swing Seats, Deck Tops, Duo/Dizzy Disc Tops.
- 8 **High Pressure Laminate** - all Toddlerzone, Playzone and Teenzone Panels.
- 9 **Steel Core Polypropylene Rope** - all Scramble Nets, Space Nets, Playzone/Toddlerzone Ropes.

Good design  
for children  
**SutcliffePlay**

	Interval (Days)				
	7	14	28	56	365
Check stability of structure, tighten connections if required.	<input type="checkbox"/>	<input type="checkbox"/>	<input type="checkbox"/>	<input checked="" type="checkbox"/>	<input type="checkbox"/>
Check all uprights at ground level for corrosion and/or rot. Replace any defective parts.	<input type="checkbox"/>	<input type="checkbox"/>	<input type="checkbox"/>	<input type="checkbox"/>	<input checked="" type="checkbox"/>
Check all painted elements for damage, rub down and repaint or replace as required.	<input type="checkbox"/>	<input type="checkbox"/>	<input type="checkbox"/>	<input checked="" type="checkbox"/>	<input type="checkbox"/>
Check chain/ropework assemblies for wear and damage, replace if required.	<input type="checkbox"/>	<input checked="" type="checkbox"/>	<input type="checkbox"/>	<input type="checkbox"/>	<input type="checkbox"/>
Check rotating and pivot points for wear and smooth running lubricate or replace if required.	<input type="checkbox"/>	<input type="checkbox"/>	<input checked="" type="checkbox"/>	<input type="checkbox"/>	<input type="checkbox"/>
Check rubber parts for wear and/or damage, replace if required.	<input type="checkbox"/>	<input type="checkbox"/>	<input checked="" type="checkbox"/>	<input type="checkbox"/>	<input type="checkbox"/>
Check tension cables, adjust if required.	<input type="checkbox"/>	<input type="checkbox"/>	<input checked="" type="checkbox"/>	<input type="checkbox"/>	<input type="checkbox"/>
Check wear of cables, replace if required.	<input type="checkbox"/>	<input type="checkbox"/>	<input checked="" type="checkbox"/>	<input type="checkbox"/>	<input type="checkbox"/>
Check slide chutes for smoothness and any foreign elements, remove any found.	<input type="checkbox"/>	<input type="checkbox"/>	<input checked="" type="checkbox"/>	<input type="checkbox"/>	<input type="checkbox"/>
Check rubber safety surfaces for damage and poor performance, repair or replace if required.	<input type="checkbox"/>	<input type="checkbox"/>	<input type="checkbox"/>	<input checked="" type="checkbox"/>	<input type="checkbox"/>
Check loose fill safety surfaces, remove any foreign elements,	<input type="checkbox"/>	<input type="checkbox"/>	<input checked="" type="checkbox"/>	<input type="checkbox"/>	<input type="checkbox"/>