

design
make
play

SutcliffePlay

Waggon Lane
Upton Pontefract
West Yorkshire WF9 1JS
Telephone +44 (0) 1977 653200
Facsimile +44 (0) 1977 653222
info@sutcliffeplay.co.uk
www.sutcliffeplay.co.uk

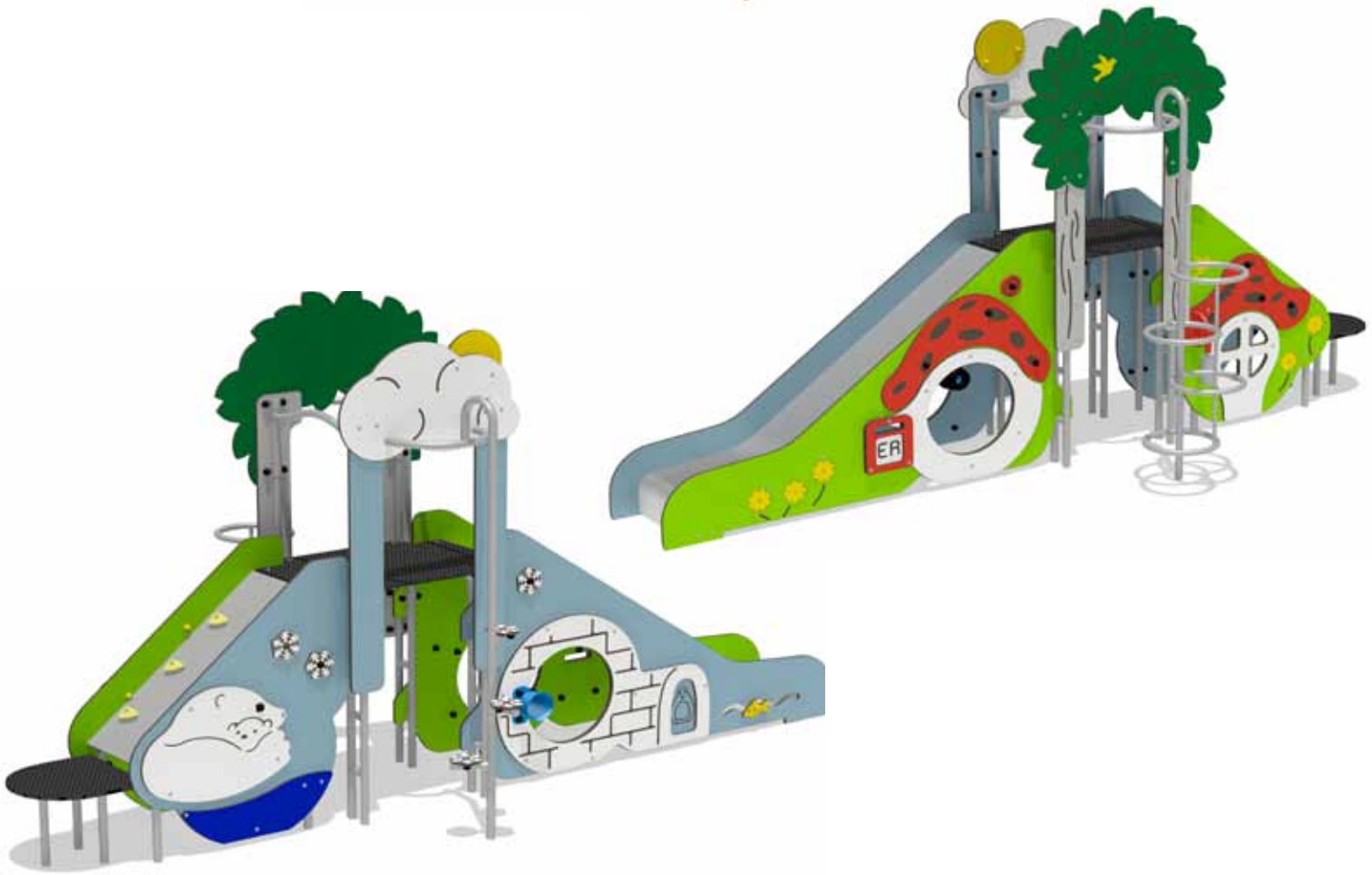

Mushroom/Igloo Themed Unit THU002

Installation Instructions

THU002

Themed Unit Installation Instructions

1. Check using the parts list that all components have been delivered.
2. Plan the final position of the play equipment, ensuring there is sufficient space
NB: Please consider the extent and HIC of surfacing (see surfacing plan).
Stainless steel slides should face north or be shaded to prevent over heating.
3. Excavate the foundation holes in accordance with the plan and play level, ensuring holes are dug to an equal level relative to each other.
4. Sort and identify parts before assembly.
5. Bolt the pedestals (PED302) to the end of the slide assembly (THS102), and position 2 spragging irons (MSL002) into the holes provided at the bottom of the pedestals. Hook this slide assembly on to the top cross-bars of one of the main frames (THF001) and stand these in their respective foundation holes.
6. Sit the ramp frame (THF121) into the foundation holes and bolt the ramp side panels (THA049 and THP056) to the frame.
7. The second main frame (THF001) can be sat into it's foundations and the ramp assembly hooked onto it.
8. Sit the Hexaboard plywood deck (THD001) between the two main frameworks and ensure at this point that all metal framework is assembled together.
9. Assemble the panels onto the posts using the supplied brackets (PZA700 and PZA705), using the images supplied as a reference for layering. See page 7 for details of panel assembly.

NB: Use the panel fixing general sheet supplied to select the correct bolts from the fixing kit (be advised that a few surplus fixings are generally included). We suggest fixing countersunk bolts first as on occasion another panel may be layered on top of them. It is important not to fully tighten the fixings until all panels have been assembled and the unit is stood within the foundation holes.

THU002

Themed Unit Installation Instructions

10. The ring climber (THF140GRY) and the step climber (THF145GRY) can now be positioned in their foundation holes and bolted to their respective panels (ring climber to tree trunks, step climber to cloud). THP060 panels can now be bolted to the plates of the step climber. THF140GRY needs two steel irons found in the fixing kit feeding through the holes in the end, prior to concreting.
11. Tighten all fixings when the unit has been fully assembled, sat into the foundation holes (before concrete is poured) and the unit is completely level and in the correct position.
12. Ensure all exposed hex-head bolts are capped off using the step washers and nylon caps provided (refer to panel fixing general sheet supplied).
13. Check the unit will sit at the correct level (700mm below play level) and position as per the elevations and plans provided before now filling the foundation holes to the required depth with concrete. Float off upper surface to enable run-off away from frame posts.
14. The unit should be secured against use by any member of the public until the concrete is set and the appropriate depth and extent of surfacing has been installed (please refer to surfacing plan).
15. Follow the maintenance instructions supplied at the end of this document.

NB: During installation, care must be taken to prevent hazards to children. If you are at all unsure or have any questions, please contact the contracts department immediately for their assistance and advice.

THU002

Themed Unit Framework List

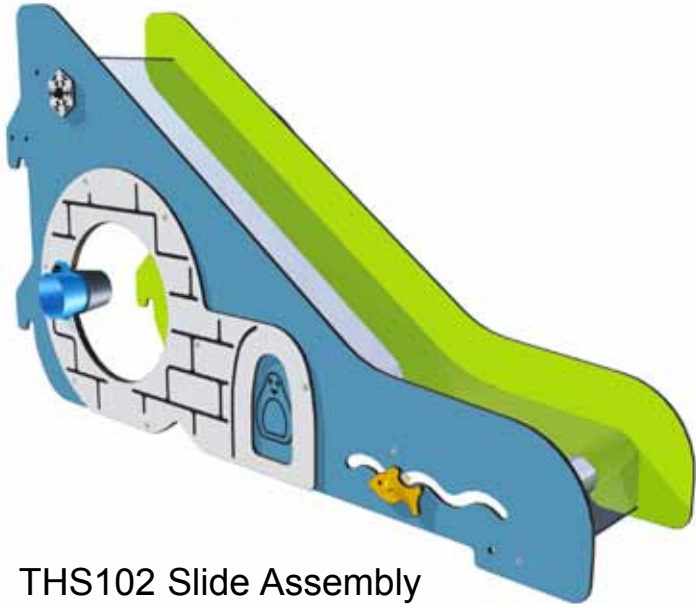

THS102 Slide Assembly

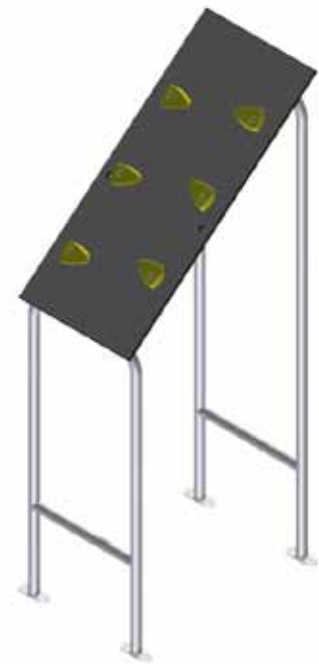

THF121



THD010

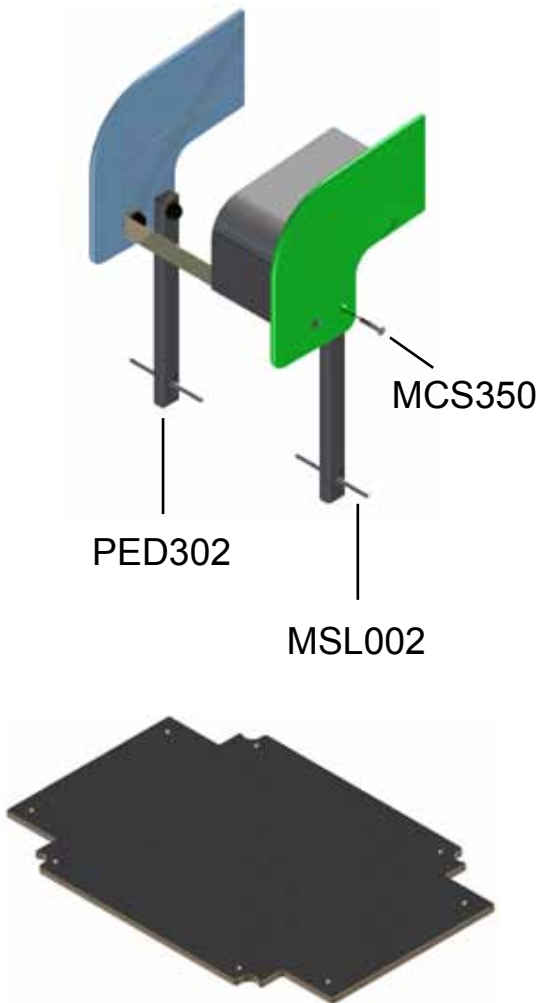

THD001

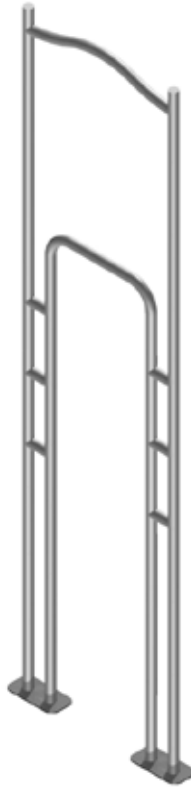

THF001GRY
x 2



THF145GRY

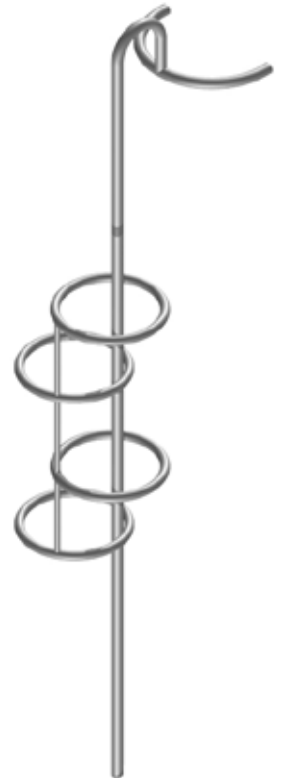

THF140GRY

THU002

Themed Unit Panels and Parts List - Mushroom Side

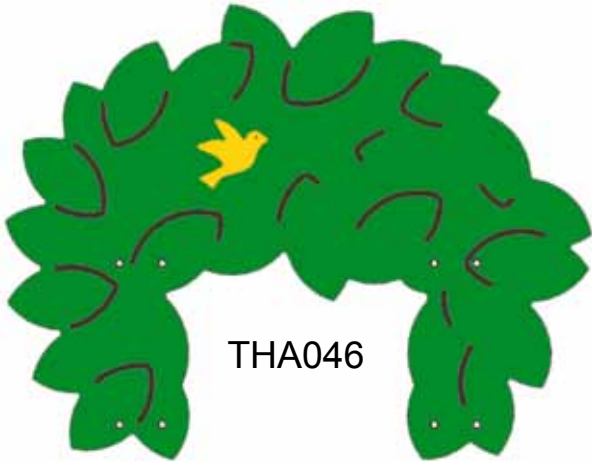

THA046

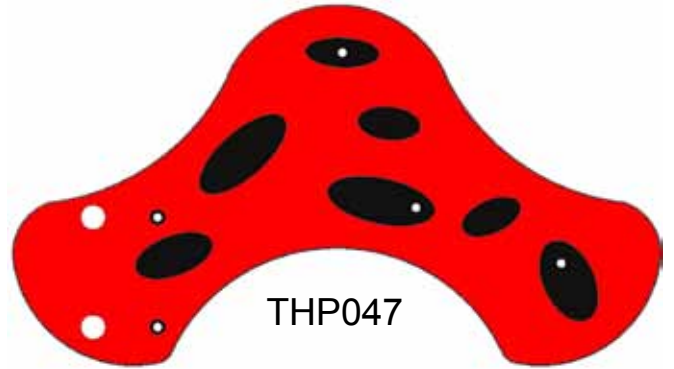

THP047



THP044



THP045



THP048

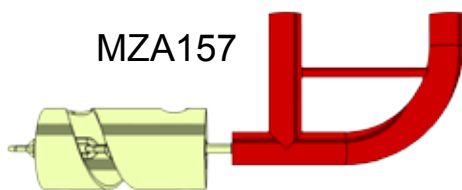

MZA157

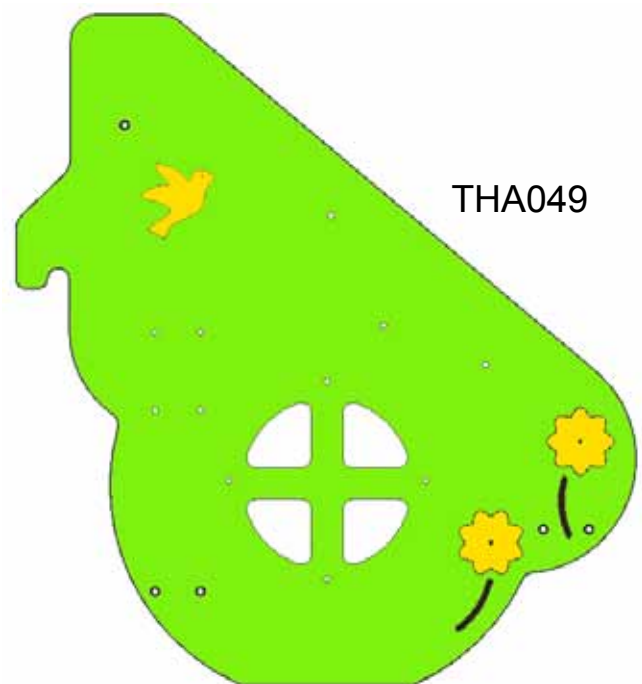

THA049

THU002

Themed Unit Panel List - Igloo Side

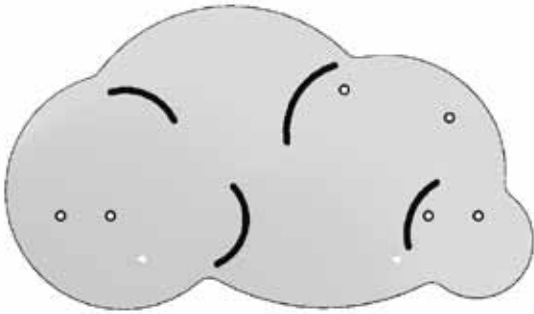

THP050

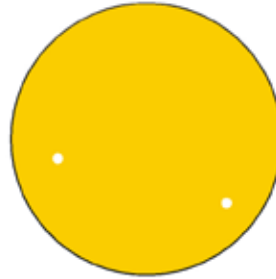

THP051



THP059



THP054LB



THP055LB

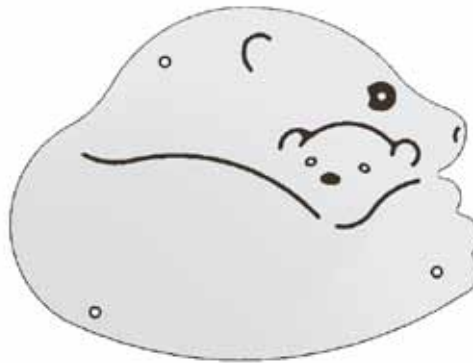

THP057



THP060
x 3



THP058

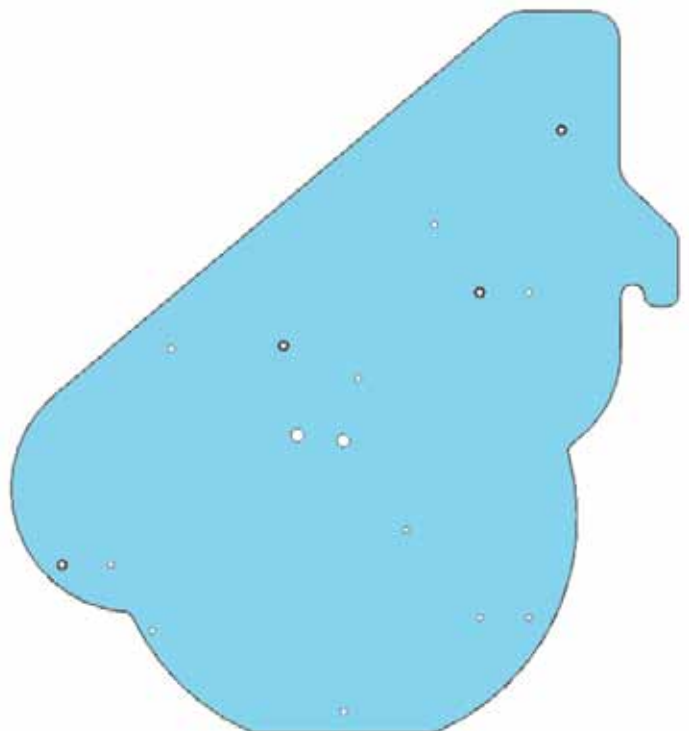

THP056

THU002

Themed Unit
Panel Assembly

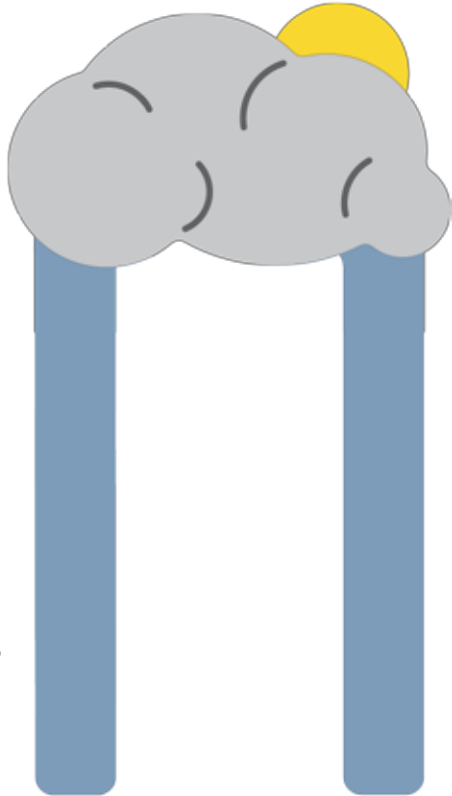

THP050

THP051

THP054LB

THP055LB

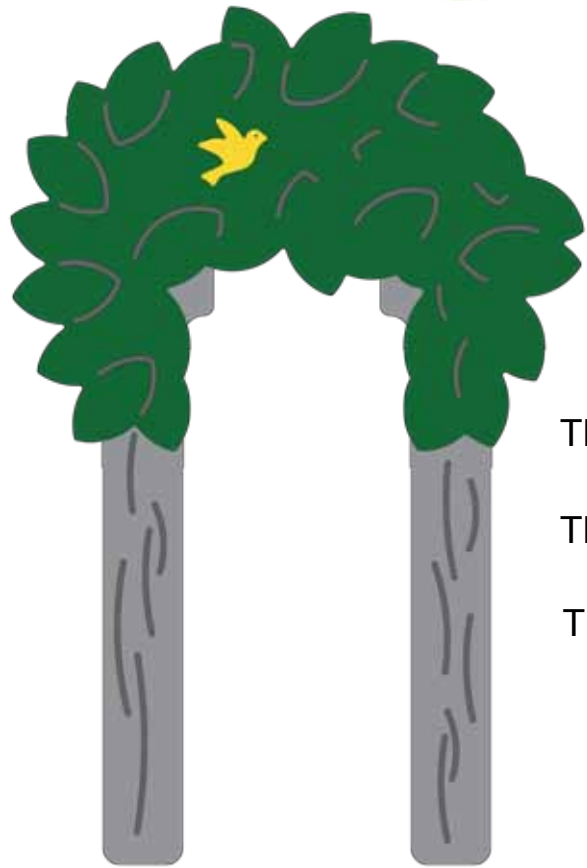

THP044

THP045

THA046

NB: These items are designed for spinning, please use fixings in accordance with the 'Panel Assembly General Sheet' supplied.

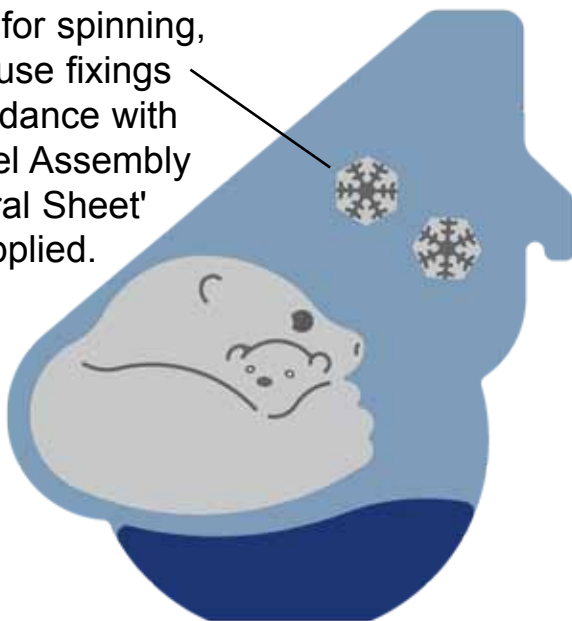

THP056

THP057

THP058

THP059



THA047

THP048

THA049

MZA157

THU002

Themed Unit Parts List

design
make
play
SutcliffePlay

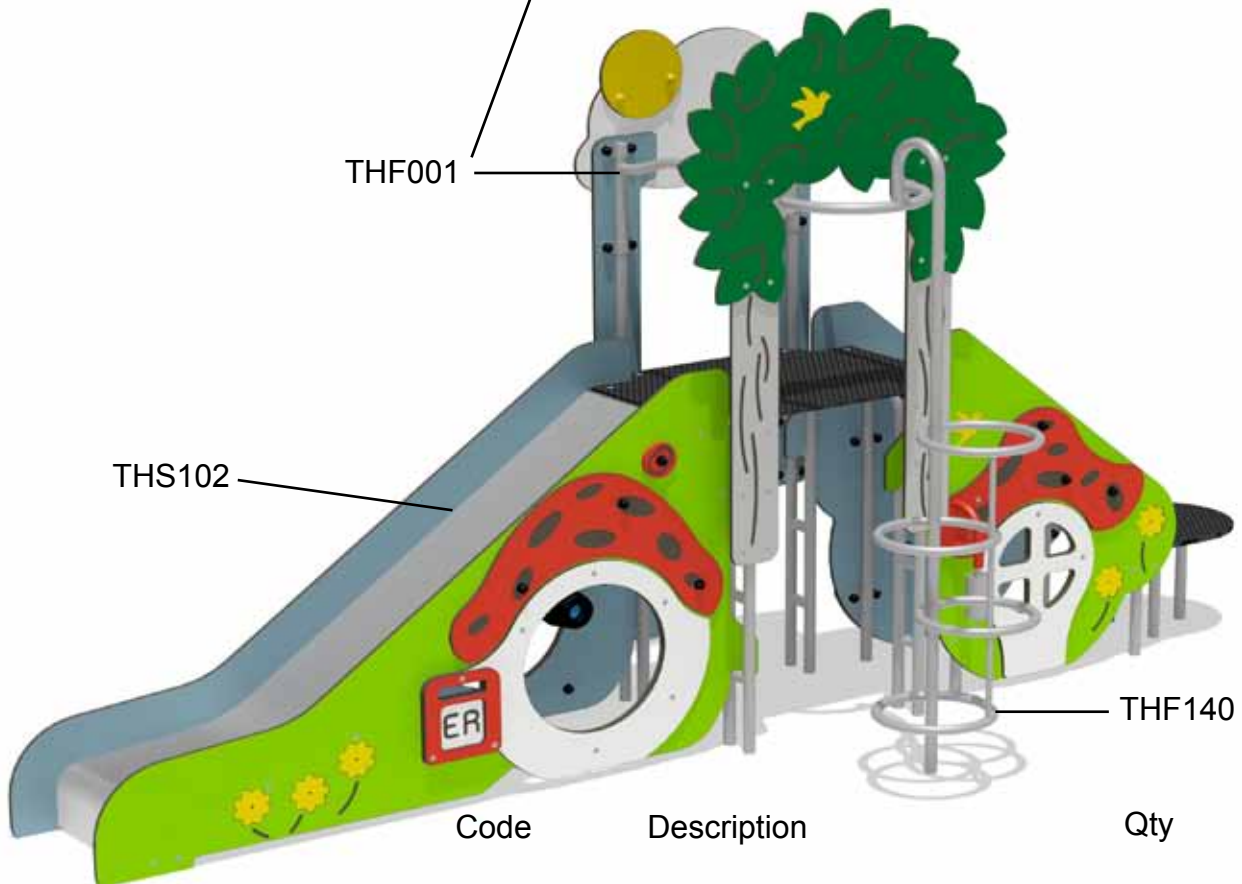
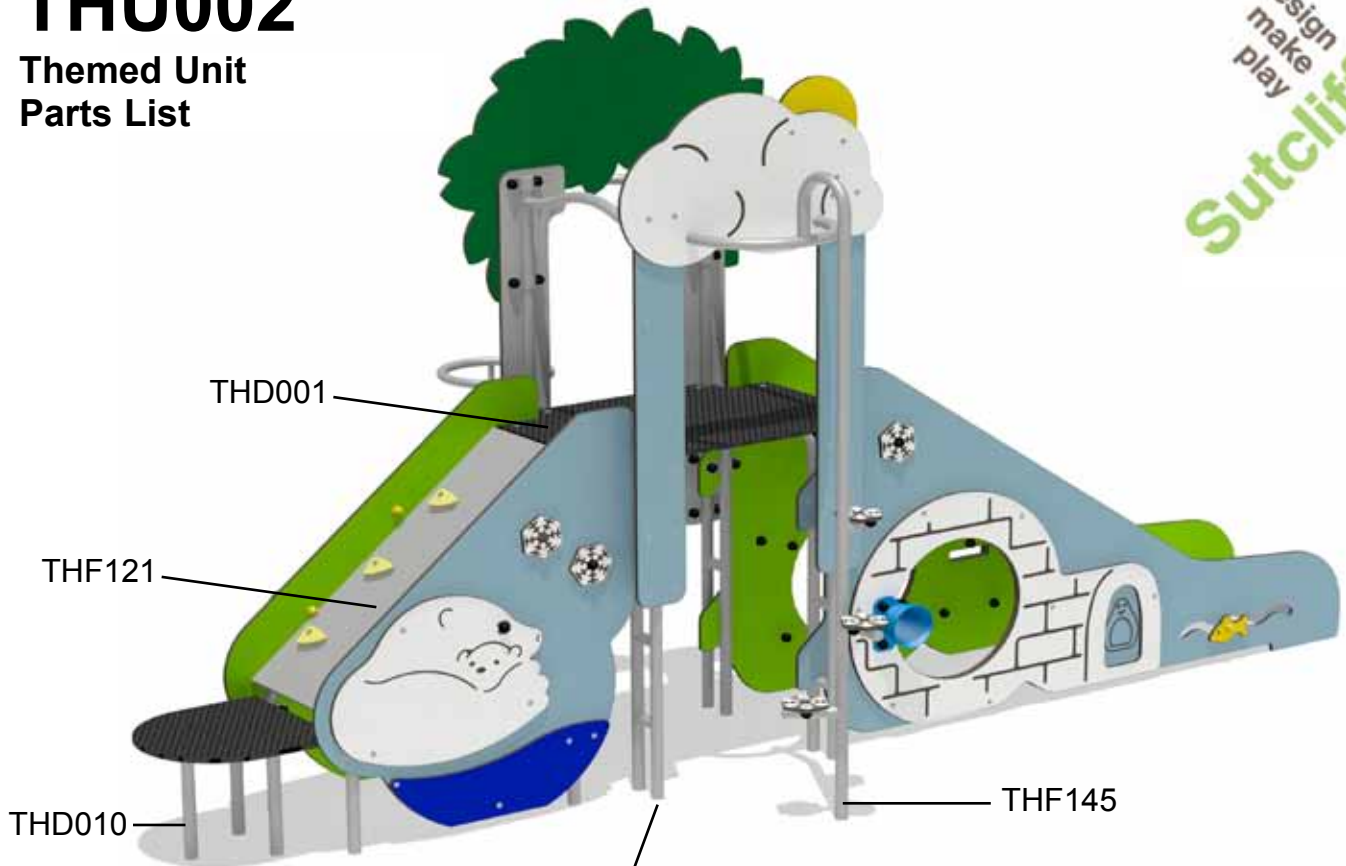

Code	Description	Qty
THS102	Seaside slide full assembly	1
THF001	Steel main frame (grey)	2
THD001	Hexaboard deck	1
THF140	Ring climber (grey)	1
THF145	Step climber (grey)	1
THD010	Transfer deck full assembly	1
THF121	Theme ramp full assembly	1
THU002F	Fixing kit	1

THU002

Themed Unit Maintenance Instructions

NB: The warranty is invalidated if these instructions are not followed.
All wood needs annual inspection and retreatment where required.

Recommended Regular Inspection and Maintenance

	Interval Days				
	7	14	28	56	365
Check stability of structure, tighten connections if required.	<input type="checkbox"/>	<input type="checkbox"/>	<input type="checkbox"/>	<input checked="" type="checkbox"/>	<input type="checkbox"/>
Check all uprights at ground level for corrosion and/or rot. Replace any defective parts.	<input type="checkbox"/>	<input type="checkbox"/>	<input type="checkbox"/>	<input type="checkbox"/>	<input checked="" type="checkbox"/>
Check all painted elements for damage, rub down and repaint or replace as required.	<input type="checkbox"/>	<input type="checkbox"/>	<input type="checkbox"/>	<input checked="" type="checkbox"/>	<input type="checkbox"/>
Check chain/ropework assemblies for wear and damage, replace if required.	<input type="checkbox"/>	<input checked="" type="checkbox"/>	<input type="checkbox"/>	<input type="checkbox"/>	<input type="checkbox"/>
Check rotating and pivot points for wear and smooth running, lubricate or replace if required.	<input type="checkbox"/>	<input type="checkbox"/>	<input checked="" type="checkbox"/>	<input type="checkbox"/>	<input type="checkbox"/>
Check rubber parts for wear and/or damage, replace if required.	<input type="checkbox"/>	<input type="checkbox"/>	<input checked="" type="checkbox"/>	<input type="checkbox"/>	<input type="checkbox"/>
Check tension cables, adjust if required.	<input type="checkbox"/>	<input type="checkbox"/>	<input checked="" type="checkbox"/>	<input type="checkbox"/>	<input type="checkbox"/>
Check wear of cables, replace if required.	<input type="checkbox"/>	<input type="checkbox"/>	<input checked="" type="checkbox"/>	<input type="checkbox"/>	<input type="checkbox"/>
Check slide chutes for smoothness and any foreign elements, remove any found.	<input type="checkbox"/>	<input type="checkbox"/>	<input checked="" type="checkbox"/>	<input type="checkbox"/>	<input type="checkbox"/>
Check rubber safety surfaces for damage and poor performance, repair or replace if required.	<input type="checkbox"/>	<input type="checkbox"/>	<input type="checkbox"/>	<input checked="" type="checkbox"/>	<input type="checkbox"/>
Check loose fill safety surfaces, remove any foreign elements, rake level and top up if required.	<input type="checkbox"/>	<input type="checkbox"/>	<input checked="" type="checkbox"/>	<input type="checkbox"/>	<input type="checkbox"/>

Disposal Instructions

All components should be broken down into categories of:-

- 1 **Mild Steel** - all 38mm Ø tube, step/ring climbers, welded bar, swing frames, deck frames, springie frames.
- 2 **Stainless Steel** - all slides, mirror panels.
- 3 **Aluminium** - all Playzone, Mission and Toddlerzone posts.
- 4 **Galvanised Steel** - all chains and Teenzone posts.
- 5 **Moulded Rubber Products without steel inserts** - all Mission and Toddlerzone Caps and edge details.
- 6 **Timber** - all natural timber, plywood, and MDF panels.

Wherever possible these materials should be taken to specialist recycling organisations and recycled.
In some cases where composite materials are used, then disposal at land fill sites is the only alternative such as:

- 7 **Moulded Rubber Products encasing steel inserts** - all Swing Seats, Deck Tops, Duo/Dizzy Disc Tops.
- 8 **High Pressure Laminate** - all Toddlerzone, Playzone, Minizone, Teenzone and Themed panels.
- 9 **Steel Core Polypropylene Rope** - all Scramble Nets, Space Nets, Playzone/Toddlerzone/Mission Ropes.