

design  
make  
play

# SutcliffePlay

Waggon Lane  
Upton Pontefract  
West Yorkshire WF9 1JS  
Telephone +44 (0) 1977 653200  
Facsimile +44 (0) 1977 653222  
info@sutcliffeplay.co.uk  
www.sutcliffeplay.co.uk

# Orchard Chin Up Bars

## Installation Instructions

# ORW035

# ORW035

## Chin Up Bars Installation Instructions

design  
make  
play  
**SutcliffePlay**

- 1 Read all instructions carefully before starting the assembly.
- 2 Check using the parts list and fixing kit list that none of the components are missing. If any parts are missing contact our Sales Office.
- 3 Plan the final position of the play equipment ensuring there is sufficient space. See the ground plan for recommended safety surfacing area and critical fall heights to EN1176.
- 4 Excavate the foundation holes in accordance with the plan. Orchard is designed to be installed onto a level site.
- 5 Fit the ground fixings OPA001 to the bottom of the relevant logs, following the instruction sheet on page 04.
- 6 Erect the main logs into the foundation holes using the ground plan for reference. Each log is numbered at the top, and marked at the base with an X.
- 7 Assemble the activities to the logs prior to concreting into position.
- 8 When all the activities are fitted, fill the foundation holes to the required depth with concrete.
- 9 Do not allow the equipment to be used until the concrete has set (2 - 3 days) and the required safety surfacing has been installed.
- 10 Check that all fixing bolts are fully tightened. Fit the post caps following the instruction sheet on page 04.
- 11 After one month check all bolts and tighten if necessary. After this one month period insert the rubber log plugs as described on the instruction sheets page 05 and 06.
- 12 Follow the maintenance instructions supplied.

During installation care must be taken to prevent hazards to children.  
Care should be taken if conditions are abnormal.

# ORW035

## Chin Up Bars Parts List

Rev 01

design  
make  
play

# Sutcliffe Play

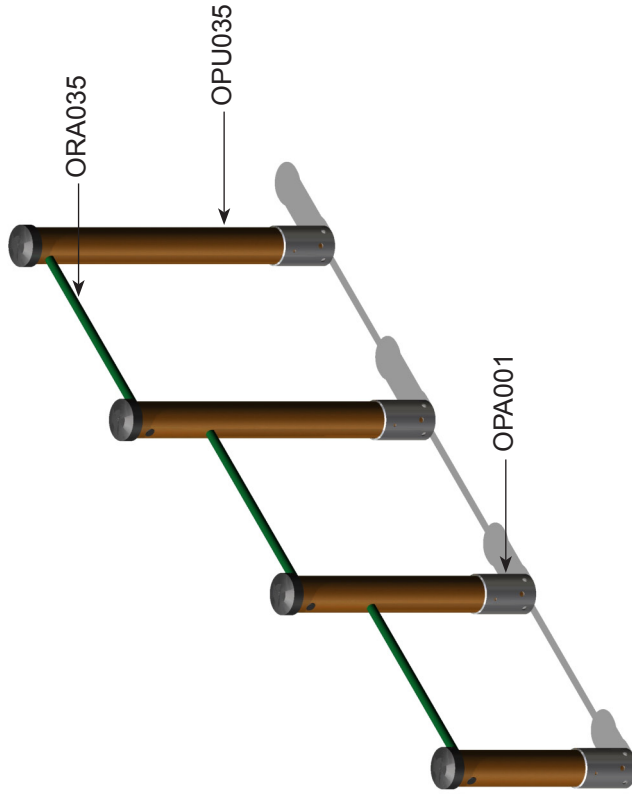

Ref	Description	Qty
OPA001	Ground Fixing 750	4
ORA035	1.0M Rail	3
OPU035	Logs (set of 4)	1 Set
ORU035F	Fixing Kit	1 Set

# ORW035

## POST CAPS

FIT RUBBER CAPS TO THE END OF THE LOGS AND FIX IN POSITION USING 3 OFF WDS450 PER JOINT.

NOTE THE RUBBER CAPS ARE A TIGHT FIT ON THE LOGS.

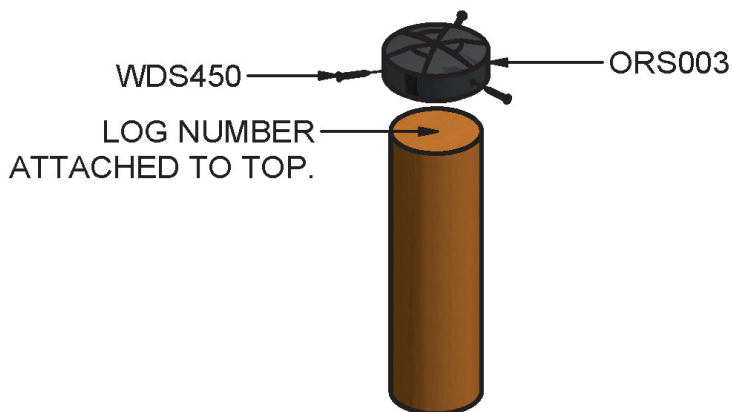

PARTS PER JOINT		
STOCK CODE	DESCRIPTION	QTY
ORS003	RUBBER POST CAP	1
WDS450	12 x 2" CSK POZI SCREW	3

## GROUND FIXINGS

**IMPORTANT NOTE**  
INSERT THE LOGS INTO THE GROUND FIXINGS 750MM. THE BOTTOM OF THE LOG SHOULD NOT PROTRUDE BEYOND THE GROUND FIXING.

ATTACH THE GOUND FIXINGS BEFORE PLACING THE LOGS IN THE FOUNDATION HOLES.

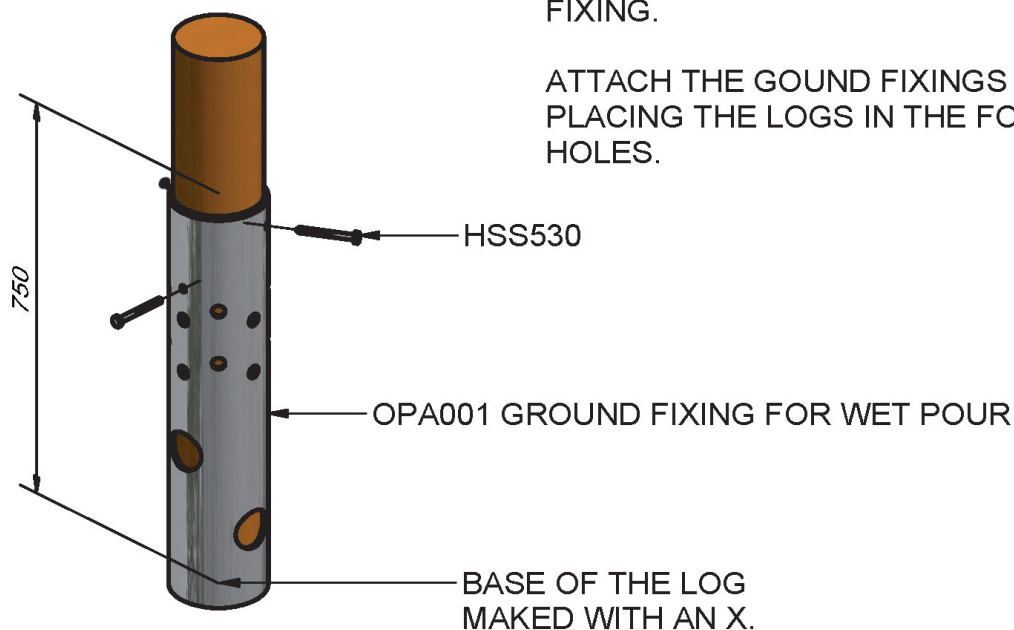

PARTS PER GROUND FIXING		
STOCK CODE	DESCRIPTION	QTY
HSS530	M10 x 100 COACH SCREW BZP	3
OPA001	ALLOY GROUND FIXING ANODIZED 750	1

# ORW035

## LOG JOINTS

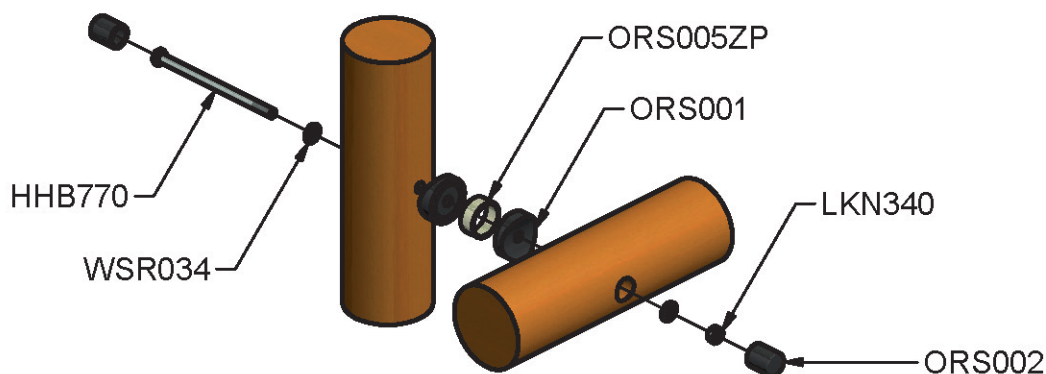

**IMPORTANT NOTE**  
TWIST THE RUBBER SPACERS  
SO THAT THEY ARE FLUSH  
AGAINST THE LOGS.

### PARTS PER LOG JOINT

STOCK CODE	DESCRIPTION	QTY
HHB770	M16 x 260 HEX HEAD BOLT	1
LKN340	M16 NYLOC NUT	1
ORS001	TIMBER RUBBER SPACER	2
ORS002	35 DIA RUBBER LOG PLUG	2
ORS005ZP	METAL SPACER RING ZINC PLATED	1
WSR034	M16 FLAT WASHER FORM C	2

## ROPE FIXINGS

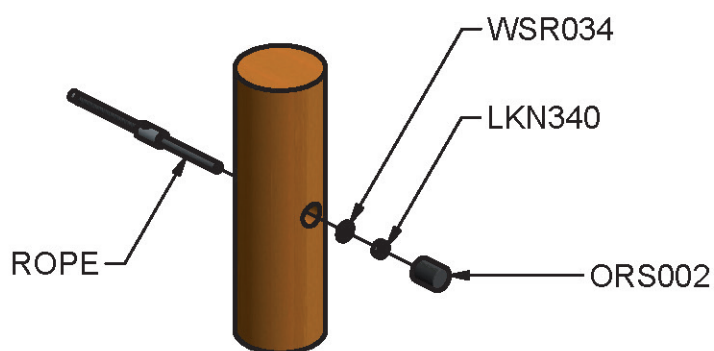

### PARTS PER ROPE JOINT

STOCK CODE	DESCRIPTION	QTY
LKN340	M16 NYLOC NUT	1
ORS002	35 DIA RUBBER LOG PLUG	1
WSR034	M16 FLAT WASHER FORM C	1

# ORW035

## HAND RING FIXING

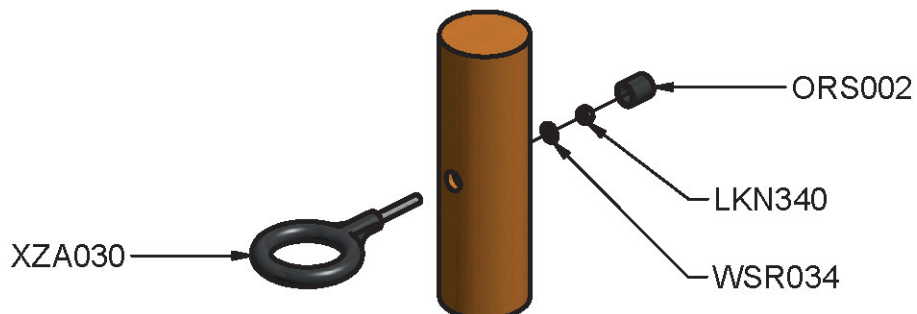

PARTS PER HAND RING		
STOCK CODE	DESCRIPTION	QTY
LKN340	M16 NYLOC NUT	1
ORS002	35 DIA RUBBER LOG PLUG	1
WSR034	M16 FLAT WASHER FORM C	1
XZA030	HAND RING MOULDING	1

## ACTIVITY FIXING

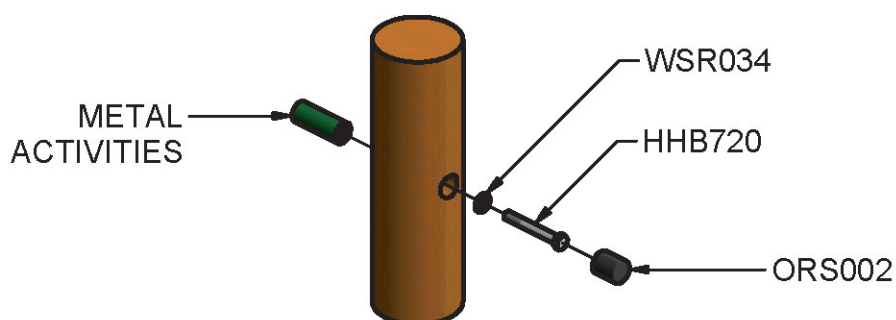

PARTS PER FIXING		
STOCK CODE	DESCRIPTION	QTY
HHB720	M16 x 120 HEX HEAD BOLT	1
ORS002	35 DIA RUBBER LOG PLUG	1
WSR034	M16 FLAT WASHER FORM C	1

# ORU035F Fixing Kit

STOCK CODE	DESCRIPTION	QTY
 HHB720	M16 x 120 HEX HEAD BOLT	8
 HHB770	M16 x 260 HEX HEAD BOLT	0
 HSS530	M10 x 80 COACH SCREW	15
 LKN340	M16 NYLOC NUT	0
 ORS001	TIMBER RUBBER SPACER	0
 ORS002	41 DIA RUBBER LOG PLUG	8
 ORS003	ORCHARD RUBBER POST CAP	4
 ORS005ZP	SPACER RING ZINC PLATED	0
 WDS450	No12 x 2" CSK POZI SCREW	15
 WSR034	M16 FLAT WASHER	8

# ORW035

## Chin Up Bars Maintenance Instructions



### NOTE

The warranty is invalidated if these instructions are not followed.

All wood needs annual inspection and retreatment where required.

### Recommended Regular Inspection and Maintenance

	Interval Days				
	7	14	28	56	365
Check stability of structure, tighten connections if required.	<input type="checkbox"/>	<input type="checkbox"/>	<input type="checkbox"/>	<input checked="" type="checkbox"/>	<input type="checkbox"/>
Check all uprights at ground level for corrosion and/or rot. Replace any defective parts.	<input type="checkbox"/>	<input type="checkbox"/>	<input type="checkbox"/>	<input type="checkbox"/>	<input checked="" type="checkbox"/>
Check all painted elements for damage, rub down and repaint or replace as required.	<input type="checkbox"/>	<input type="checkbox"/>	<input type="checkbox"/>	<input checked="" type="checkbox"/>	<input type="checkbox"/>
Check chain/ropework assemblies for wear and damage, replace if required.	<input type="checkbox"/>	<input checked="" type="checkbox"/>	<input type="checkbox"/>	<input type="checkbox"/>	<input type="checkbox"/>
Check rotating and pivot points for wear and smooth running lubricate or replace if required.	<input type="checkbox"/>	<input type="checkbox"/>	<input checked="" type="checkbox"/>	<input type="checkbox"/>	<input type="checkbox"/>
Check rubber parts for wear and/or damage, replace if required.	<input type="checkbox"/>	<input type="checkbox"/>	<input checked="" type="checkbox"/>	<input type="checkbox"/>	<input type="checkbox"/>
Check tension cables, adjust if required.	<input type="checkbox"/>	<input type="checkbox"/>	<input checked="" type="checkbox"/>	<input type="checkbox"/>	<input type="checkbox"/>
Check wear of cables, replace if required.	<input type="checkbox"/>	<input type="checkbox"/>	<input checked="" type="checkbox"/>	<input type="checkbox"/>	<input type="checkbox"/>
Check slide chutes for smoothness and any foreign elements, remove any found.	<input type="checkbox"/>	<input type="checkbox"/>	<input checked="" type="checkbox"/>	<input type="checkbox"/>	<input type="checkbox"/>
Check rubber safety surfaces for damage and poor performance, repair or replace if required.	<input type="checkbox"/>	<input type="checkbox"/>	<input type="checkbox"/>	<input checked="" type="checkbox"/>	<input type="checkbox"/>
Check loose fill safety surfaces, remove any foreign elements, rake level and top up if required.	<input type="checkbox"/>	<input type="checkbox"/>	<input checked="" type="checkbox"/>	<input type="checkbox"/>	<input type="checkbox"/>

### Disposal Instructions

All components should be broken down into categories of:-

- 1 **Mild Steel** - all Swing Frames, Playzone, Toddlerzone, Teenzone activities, Mission, Orchard Deck Frames and Springie Frames.
- 2 **Stainless Steel** - all Slides, Mirror Panels.
- 3 **Aluminium** - all Playzone, Mission and Toddlerzone Posts.
- 4 **Galvanised Steel** - all Chains and Teenzone Posts.
- 5 **Moulded Rubber Products without steel inserts** - all Mission and Toddlerzone Caps and edge details.
- 6 **Timber** - all natural timber, plywood, and MDF panels.

Wherever possible these materials should be taken to specialist recycling organisations and recycled.

In some cases where composite materials are used, then disposal at land fill sites is the only alternative such as:

- 7 **Moulded Rubber Products encasing steel inserts** - all Swing Seats, Deck Tops, Duo/Dizzy Disc Tops.
- 8 **High Pressure Laminate** - all Toddlerzone, Playzone and Teenzone Panels.
- 9 **Steel Core Polypropylene Rope** - all Scramble Nets, Space Nets, Playzone/Toddlerzone/Mission Ropes.