

**PLAN SCALE 1:50**

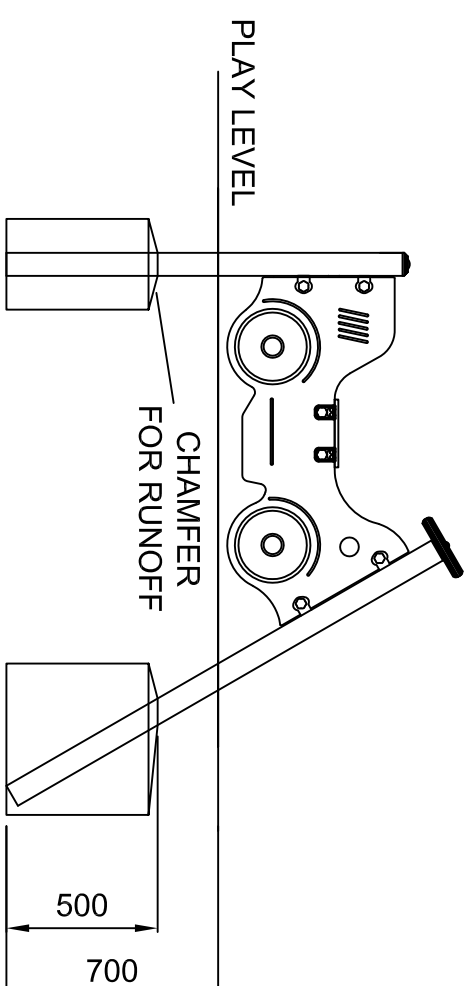

MINIMUM USE ZONE  
 REQUIREMENTS TO EN 1176  
 PERIMETER 13.52M  
 AREA - 13.44m<sup>2</sup>  
 NO SAFETY SURFACING REQUIRED  
 WHEN INSTALLED IN TO GRASS

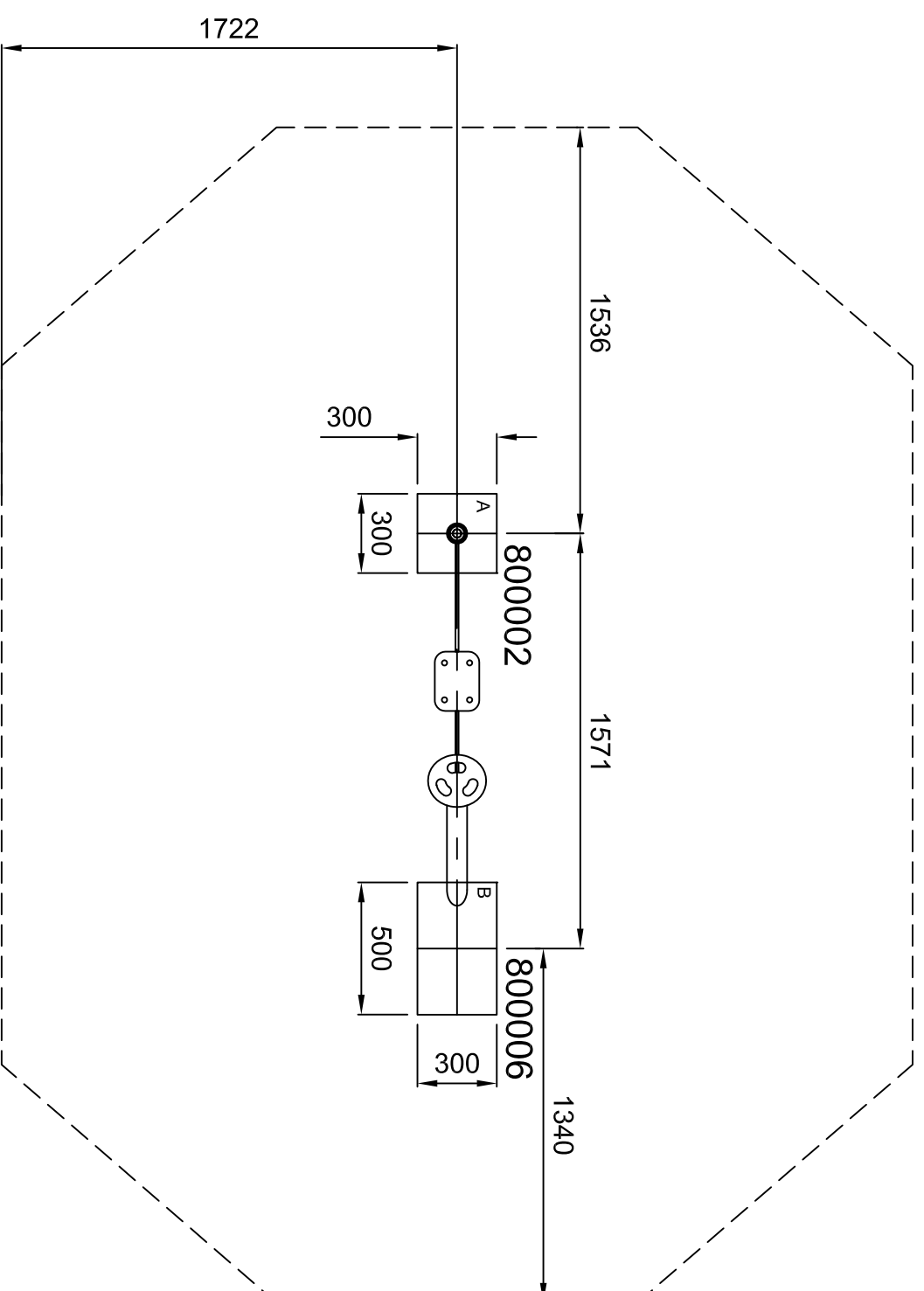

**DO NOT SCALE THIS DRAWING**  
**SCALE 1:25 WHEN PRINTED ON A3**

GROUND PLAN	<b>MTU005</b>
REV	00
DRAWN	PM
SCALE	1:25 @ A3
DATE	15.07.16
SAFETY SURFACE AREA	NOT REQUIRED ON TO GRASS
HOLE A 300X300X700 DEEP	
HOLE B 500X300X700 DEEP	