

**Good design
for children**

SutcliffePlay

**Waggon Lane
Upton Pontefract
West Yorkshire WF9 1JS
Telephone +44 (0)1977 653200
Facsimile +44 (0)1977 653222
info@ sutcliffeplay.co.uk
www. sutcliffeplay.co.uk**

Toddlerzone

Installation Instructions

DZW273

DZW273

Toddlerzone Unit Installation Instructions

Good design
for children
SutcliffePlay

- 1 Check using the Parts List that none of the components are missing.
- 2 Plan the final position of the play equipment ensuring there is sufficient space.
- 3 Stainless steel slides should face north or be shaded to prevent over heating. Slide runouts should be inclined downwards by approximately 2 degrees for drainage purposes.
- 4 Excavate the foundation holes in accordance with the plan.
- 5 Sort and identify parts before assembly. Each leg is numbered to correspond with the foundation plan.
- 6 Position 2 off 300 long spragging irons into the hoes provided in each post upright and stand in the foundation holes. Assemble the decks at the positions marked on the posts. Do not tighten the fixing bolts until all the activities have been assembled.
- 7 Assemble the activities onto the posts. Leave fixing bolts loose until all the activities have been assembled.
- 8 Fill the foundation holes to the required depth with concrete.
- 9 Do not allow the equipment to be used until the concrete has set (2 - 3 days) and the required safety surfacing has been installed.
- 10 Tighten all fixing bolts.
- 11 Follow the maintenance instructions supplied.

During installation care must be taken to prevent hazards to children.
Care should be taken if conditions are abnormal.

DZW273

Toddlerzone Unit

Parts list

Good design
for children

Sutcliffe Play

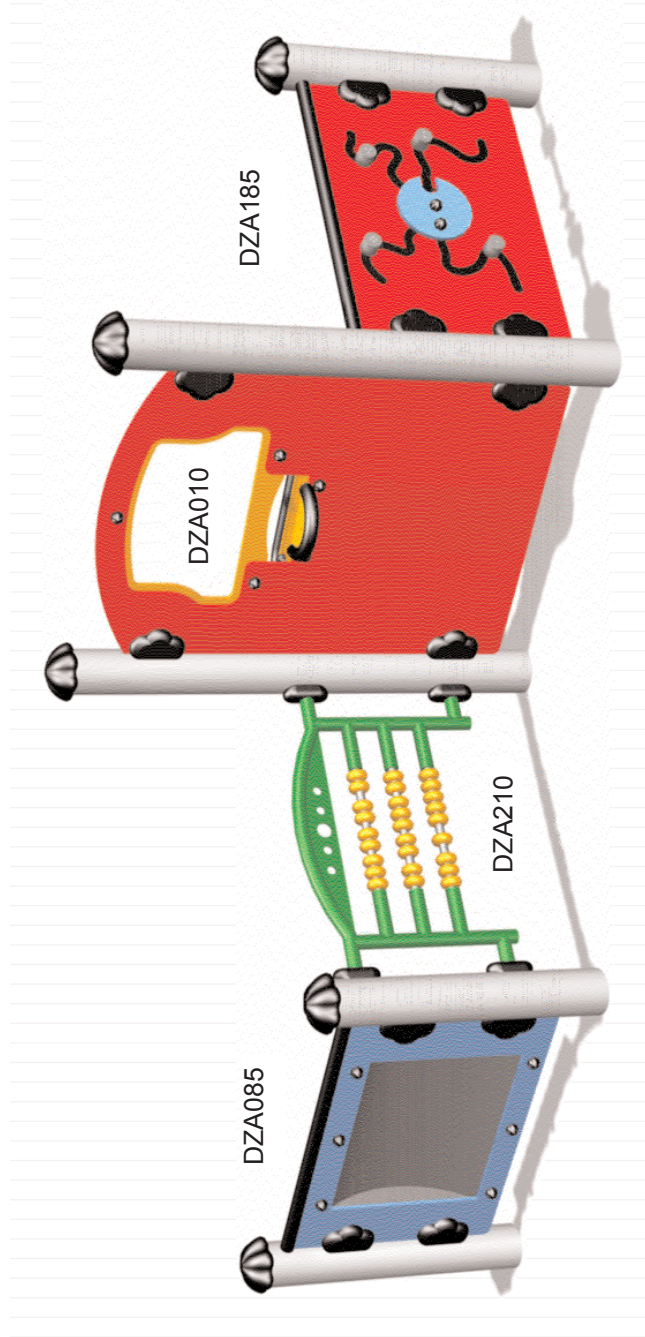

Ref	Description	Qty
DZA210	Abacus rail	1
DZA010	Shop panel	1
DZA185	Rotary puzzle panel	1
DZA085	Mirror panel	1
DPW273	Posts (set of 5)	1 set
DZU273F	Loose fixings	1 set

DZW273

Toddlerzone Unit

Maintenance Instructions



Recommended Regular Inspection and Maintenance

	Interval (days)				
	7	14	28	56	365
Check stability of structure, tighten connections if required.	<input type="checkbox"/>	<input type="checkbox"/>	<input type="checkbox"/>	<input checked="" type="checkbox"/>	<input type="checkbox"/>
Check all uprights at ground level for corrosion and/or rot. Replace any defective parts.	<input type="checkbox"/>	<input type="checkbox"/>	<input type="checkbox"/>	<input type="checkbox"/>	<input checked="" type="checkbox"/>
Check all painted elements for damage, rub down and repaint or replace as required.	<input type="checkbox"/>	<input type="checkbox"/>	<input type="checkbox"/>	<input checked="" type="checkbox"/>	<input type="checkbox"/>
Check chain/ropework assemblies for wear and damage, replace if required.	<input type="checkbox"/>	<input checked="" type="checkbox"/>	<input type="checkbox"/>	<input type="checkbox"/>	<input type="checkbox"/>
Check rotating and pivot points for wear and smooth running lubricate or replace if required.	<input type="checkbox"/>	<input type="checkbox"/>	<input checked="" type="checkbox"/>	<input type="checkbox"/>	<input type="checkbox"/>
Check rubber parts for wear and/or damage, replace if required.	<input type="checkbox"/>	<input type="checkbox"/>	<input checked="" type="checkbox"/>	<input type="checkbox"/>	<input type="checkbox"/>
Check tension cables, adjust if required.	<input type="checkbox"/>	<input type="checkbox"/>	<input checked="" type="checkbox"/>	<input type="checkbox"/>	<input type="checkbox"/>
Check wear of cables, replace if required.	<input type="checkbox"/>	<input type="checkbox"/>	<input checked="" type="checkbox"/>	<input type="checkbox"/>	<input type="checkbox"/>
Check slide chutes for smoothness and any foreign elements, remove any found.	<input type="checkbox"/>	<input type="checkbox"/>	<input checked="" type="checkbox"/>	<input type="checkbox"/>	<input type="checkbox"/>
Check rubber safety surfaces for damage and poor performance, repair or replace if required.	<input type="checkbox"/>	<input type="checkbox"/>	<input type="checkbox"/>	<input checked="" type="checkbox"/>	<input type="checkbox"/>
Check loose fill safety surfaces, remove any foreign elements, rake level and top up if required.	<input type="checkbox"/>	<input type="checkbox"/>	<input checked="" type="checkbox"/>	<input type="checkbox"/>	<input type="checkbox"/>

Disposal Instructions

All components should be broken down into categories of:-

- 1 **Mild Steel** - all Swing Frames, Playzone, Toddlerzone, Teenzone activities, Deck Frames and Springie Frames.
- 2 **Stainless Steel** - all Slides, Mirror Panels.
- 3 **Aluminium** - all Playzone and Toddlerzone Posts.
- 4 **Galvanised Steel** - all Chains and Teenzone Posts.
- 5 **Moulded Rubber Products without steel inserts** - all Toddlerzone Caps and edge details.
- 6 **Timber** - all natural timber, plywood, and MDF panels.

Wherever possible these materials should be taken to specialist recycling organisations and recycled.

In some cases where composite materials are used, then disposal at land fill sites is the only alternative such as:

- 7 **Moulded Rubber Products encasing steel inserts** - all Swing Seats, Deck Tops, Duo/Dizzy Disc Tops.
- 8 **High Pressure Laminate** - all Toddlerzone, Playzone and Teenzone Panels.
- 9 **Steel Core Polypropylene Rope** - all Scramble Nets, Space Nets, Playzone/Toddlerzone Ropes.

Toddlerzone Installation Instructions Rotary Puzzle Panel DZA175

Good design
for children

SutcliffePlay

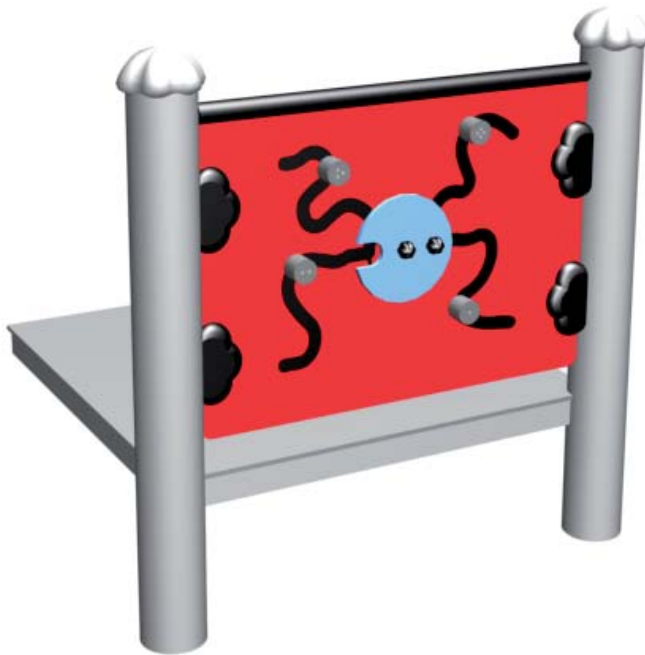
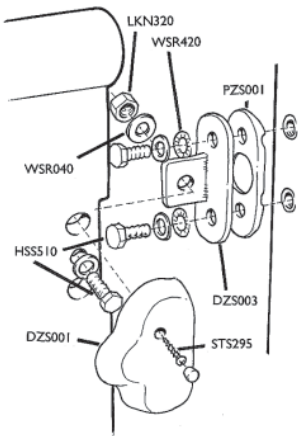

- Prepare holes for posts to required dimensions (if not already drilled).
- Ensure the posts are vertical and the threaded inserts are absolutely parallel to each other.
- Place bracket DZS003 and plastic base PZS001 onto posts and fix loosely with HSS510 M10 x 30 screws and washers.
- Place puzzle panel in position and fix loosely with 4 screws, washers and nuts.
- Centralise panel between the brackets and lightly tighten the 4 screws on the panel.
- Adjust the height of the panel so that the screws are central in the bracket slots and loosely tighten. Ensure puzzle disc spins freely and tighten the 4 panel screws.
- Tighten the bracket screws, ensuring that the disc continues to spin freely.
If the disc is tight, the panel has distorted during the tightening process. Slacken the 8 bracket screws slightly and manipulate the panel to re-site the brackets. Re-tighten, ensuring disc is still free.
- Fix panel fixing covers in place.
- Concrete posts according to installation instructions.

Toddlerzone Installation Instruction

Fixing details

Good design
for children

SutcliffePlay

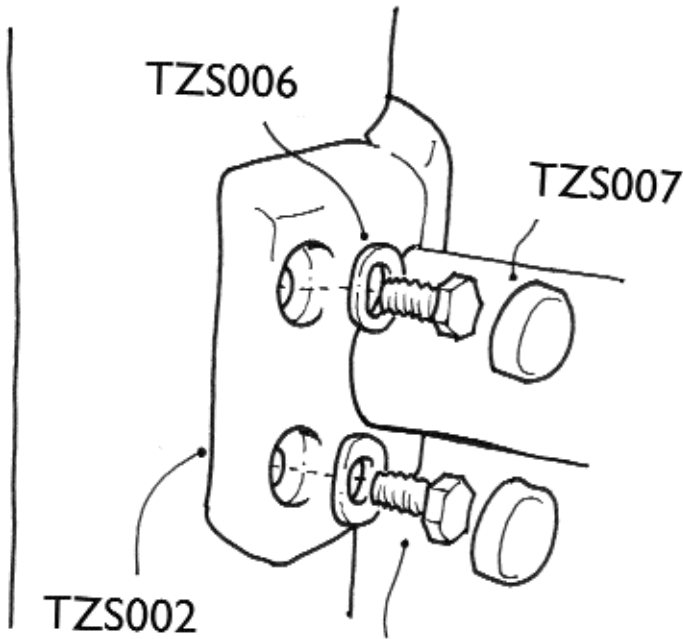

Teenzone Fixing

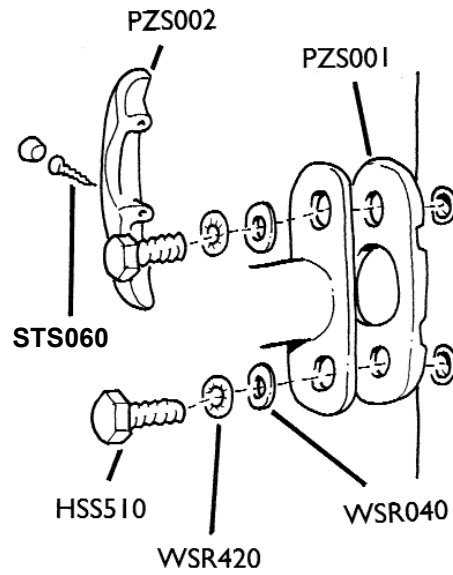

Post Fixing

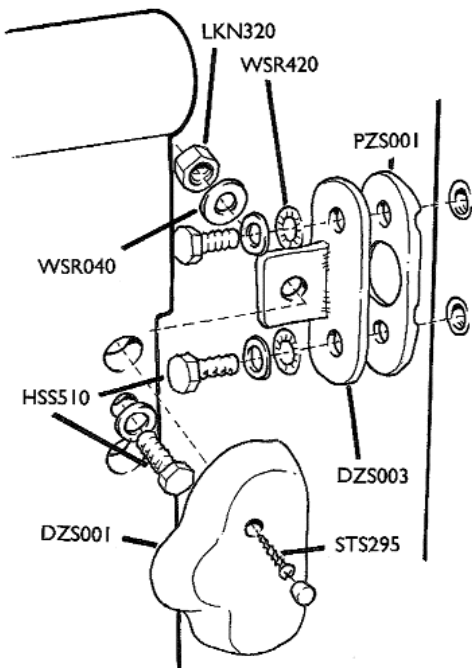

Panel Fixing

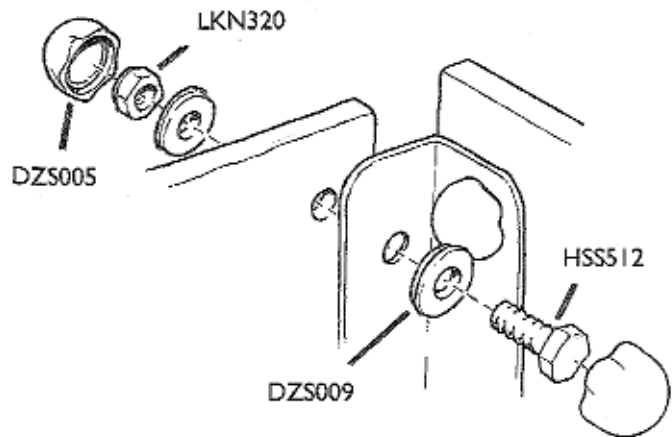

Bracket Fixing

Toddlerzone Installation Instruction

Panel Fixing details

Good design
for children

SutcliffePlay

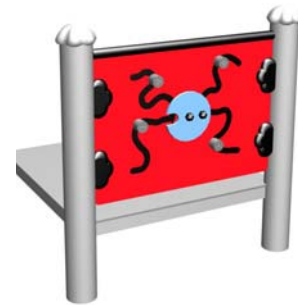
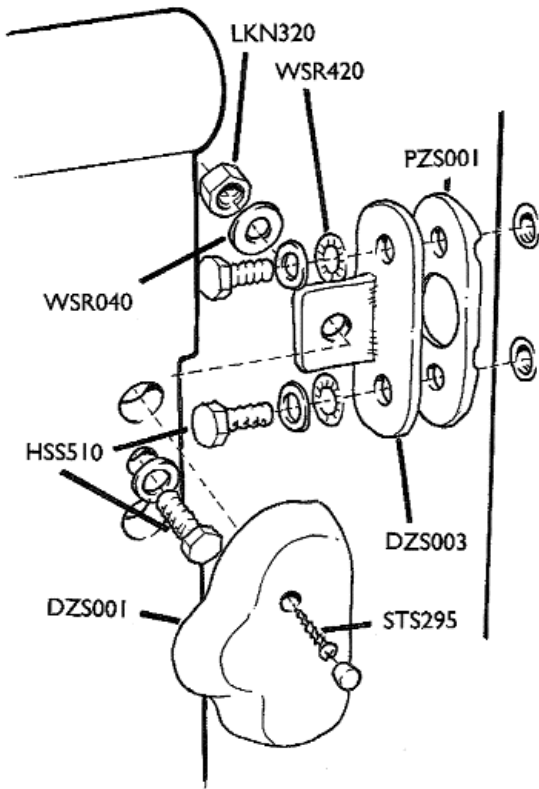

IMPORTANT NOTE

When installing the Puzzle Panel (DZA185) ensure the uprights are vertical and parallel. If the uprights are twisted then the panel will be twisted and the puzzle pieces will stick and not move freely.

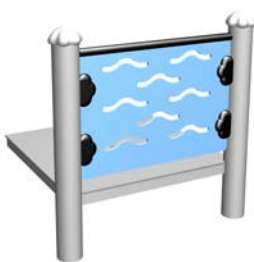

DZA080



DZA070

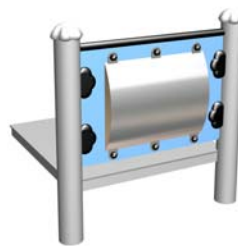

DZA085



DZA010



DZA090



DZA065

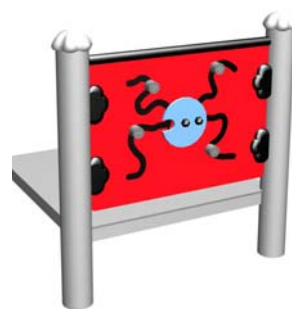

DZA185

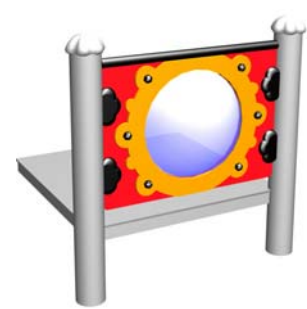

DZA220

Toddlerzone Installation Instructions

Good design
for children
SutcliffePlay

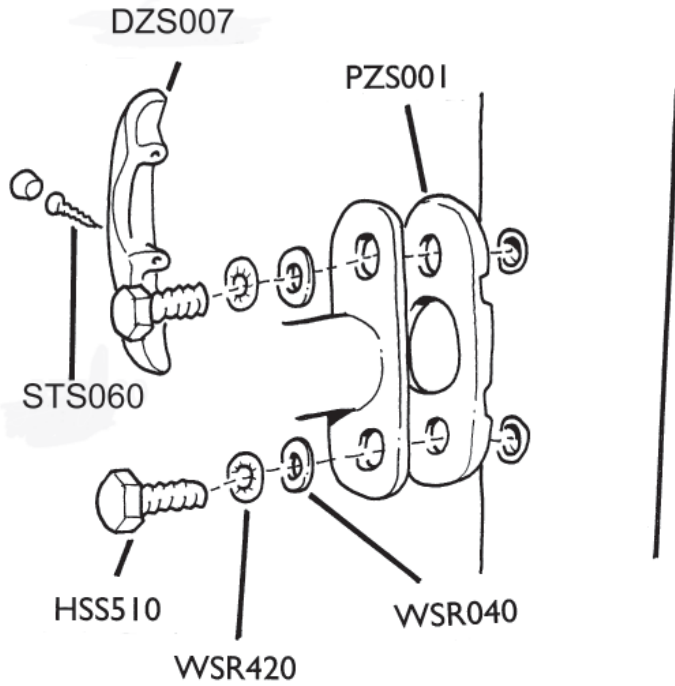

DZA340

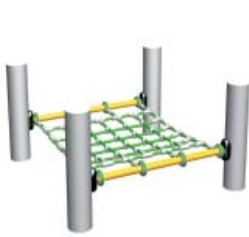

DZA150



DZA015



DZA115, DZA120,
DZA125



DZA055



DZA205



DZA075



DZA040



DZA130, DZA135,
DZA140



DZA105, DZA110



DZA005

DZA170

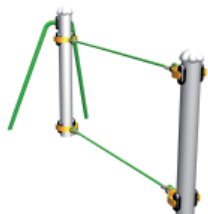

DZA145



DZA255



DZA095



DZA210



DZA215