

design
make
play

SutcliffePlay

Waggon Lane
Upton Pontefract
West Yorkshire WF9 1JS
Telephone +44 (0) 1977 653200
Facsimile +44 (0) 1977 653222
info@sutcliffeplay.co.uk
www.sutcliffeplay.co.uk



Cableway

Installation Instructions

CAM030R

CAM030R

Cableway Installation Instructions

design
make
play
SutcliffePlay

1. Read all instructions carefully before starting the assembly.
2. Check using the Parts List and Fixing Kit List that none of the components are missing. If any parts are missing please contact our Sales Office.
3. Plan the final position of the Cableway ensuring that there is sufficient space. See the Ground Plan for recommended impact area in accordance with EN1176-4.
4. Excavate the foundation holes for the Start and End Stations in accordance with the Ground Plan. Shuttering may be required for the Start Station foundation holes if excavating into an existing mound. Ensure the Start and End Stations are the correct distance apart and the height differential of 1M is achieved.
5. Assemble the Start and End Stations into the foundation holes in accordance with Fig 1. Ensure all fixing bolts are securely tightened.
6. Ensure the Start and End Stations are correctly positioned then fill the foundation holes with the required depth of concrete. Profile the mound in accordance with the elevation. Cover the impact area with a suitable surface which has a HIC of 1M or greater.
7. After the concrete has set, install the cable assembly. Take care when unrolling the Cable to ensure it is free from kinks and twists. Fit the Cable Sheave and Adjuster Rod to the Start Station in accordance with Fig 3.
8. Cable Measurement. Fit the closed end of the cable to the end station in accordance with Fig 2. Temporarily hang the Cable over the Cable Sheave at the Start Station and mark the Cable where it meets the Adjuster Rod for the fitting position of the Wire Rope Thimble. The Cable must not be taught, it should have a sag of approximately 450 to 550mm in the center.
9. Cable Measurement alternative method. Measure the distance between the centre of the cable fixing hole at the end station, and the centre of the sheave fixing hole at the start station. Adding 1100mm to this dimension gives the correct cable length. from the centre of the end fixed eye, to the centre of the start station thimble.

CAM030R

Cableway Installation Instructions

design
make
play
SutcliffePlay

- 10 Slide the Long Brake Spring, followed by the Cable Trolley, followed by the Short Brake Spring onto the Cable, the Cable Trolley has a braking system, the chain connector must be pulled down to thread the Cable, ensure the plastic end guards are in place at each end of the Cable Trolley. Fit the Cable Thimble to the Cable using the 4 off Wire Rope Grips. The Wire Rope Grips must be fitted the correct way round, with the bridge of the grip on the working side of the rope. Four grips must be used with a spacing of 50MM in accordance with Fig 4.
- 11 Hang the Cable over the Cable Sheave at the Start Station and secure it to the Adjuster Rod with the Adjuster Pin and Split Pin in accordance with Fig 4. Thread any spare Cable into the hole at the back of the Start Station Post.
12. Secure the Brake Springs at the position shown on the Plan drawing. Fit the Seat Assembly to the Cable Trolley. Adjust the Cable tension and Seat Chain length to give a minimum seat clearance of 350mm when loaded to 69.5Kg. **Do not over tighten the cable or it will put excessive strain on the structure. The sag on the cable should be 450 to 550mm in the center, the seat is supplied with extra chain links so remove some of these to obtain the correct seat clearance if required.**
13. Ensure all fixings are secure and the 2 off Adjuster Nuts are tightened. Fit the Adjuster Cover in accordance with Fig 5.

Follow the Maintenance Instructions supplied.

During installation care must be taken to prevent hazards to children.
Care should be taken if conditions are abnormal.

Cable Adjustment

Periodically the Cable will need adjusting as it stretches over time. To carry out the adjustment remove the Adjuster Cover as shown in Fig 5 and using the 2 off Adjuster Nuts tension the Cable go give a minimum seat clearance of 400mm when loaded. Do not overtighten the Cable, it should have a sag of approximately 450 to 550mm in the center. Fully tighten the Adjuster Nuts and refit the Adjuster Cover.

CAM030R 30M Cableway Mound Type Parts List



ILLUSTRATION	CODE	DESCRIPTION	QTY
	CAB010GAL	LONG LEG	2
	CAB015GAL	START STATION POST	1
	CAB020GAL	SHORT LEG	2
	CAB025GAL	END STATION POST	1
	CAB030GAL	FOUNDATION TUBE	2
	CAB057R	ADJUSTER COVER RED	1
	CAM020F	FIXING KIT	1

CAM030F 30M Cableway Mound Type Fixing Kit



ILLUSTRATION	CODE	DESCRIPTION	QTY	ILLUSTRATION	CODE	DESCRIPTION	QTY
	FIX155	M10 x 30 SECURITY SCREW	5		WSR040	M10 WASHER	16
	HHB528	M10 x 75 LG HEX HEAD BOLT	6		WSR050	M12 WASHER	53
	HSS615	M12 x 35 HEX HEAD SCREW	29		WSR190	M16 WASHER	6
	HHB699	M16 x 90 HEX HEAD SCREW	4		CAB035	PLASTIC SPACER	4
	LKN320	M10 NYLOC NUT	6		FIX010	WIRE ROPE GRIP	5
	LKN330	M12 NYLOC NUT	29		FIX015	WIRE ROPE THIMBLE	2
	LKN340	M16 NYLOC NUT	4		PIN550	SPLIT PIN	3
	PLN360	M24 PLAIN NUT	4		CAB042	ADJUSTER PIN	1
	CAB063	CABLE SHEAVE	1		CAB006	32M CABLE	1
	FIX195	FIXING TOOL	1				

CAM030F 30M Cableway Mound Type Fixing Kit



ILLUSTRATION	CODE	DESCRIPTION	QTY
	CAB001	CABLEWAY TROLLEY	1
	CAB002	1.5M START SECTION BRAKE SPRING	1
	CAB003	3.0M END SECTION BRAKE SPRING	1
	CAB050	ADJUSTER ROD	1
	SRE600	CABLEWAY PENDULUM SEAT ASSY	1

CAM030R

Cableway Installation Instructions

design
make
play
SutcliffePlay

POSTS AND LEGS BUILD UP FIG 1

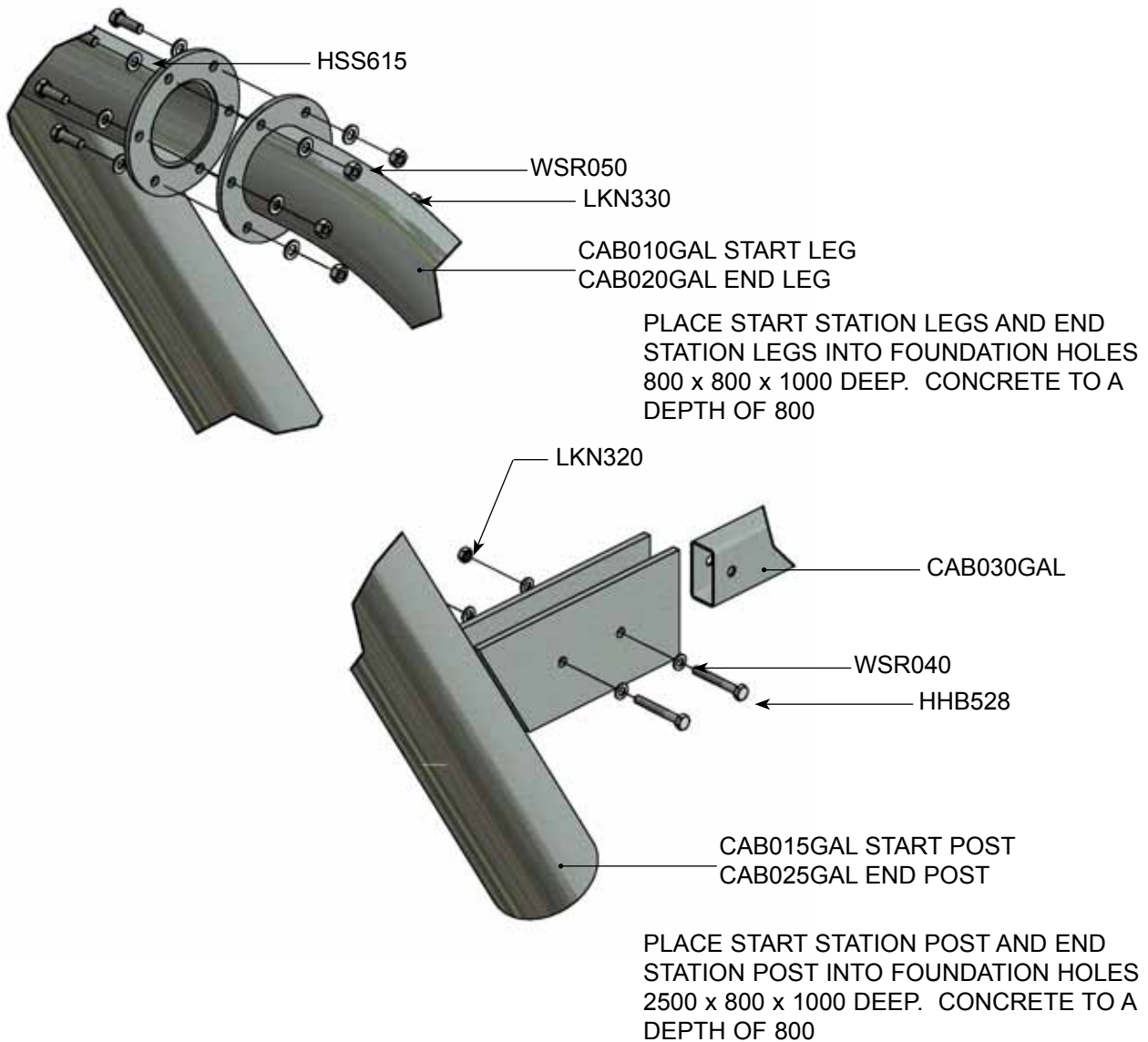

CAM030R

Cableway Installation Instructions

design
make
play

SutcliffePlay

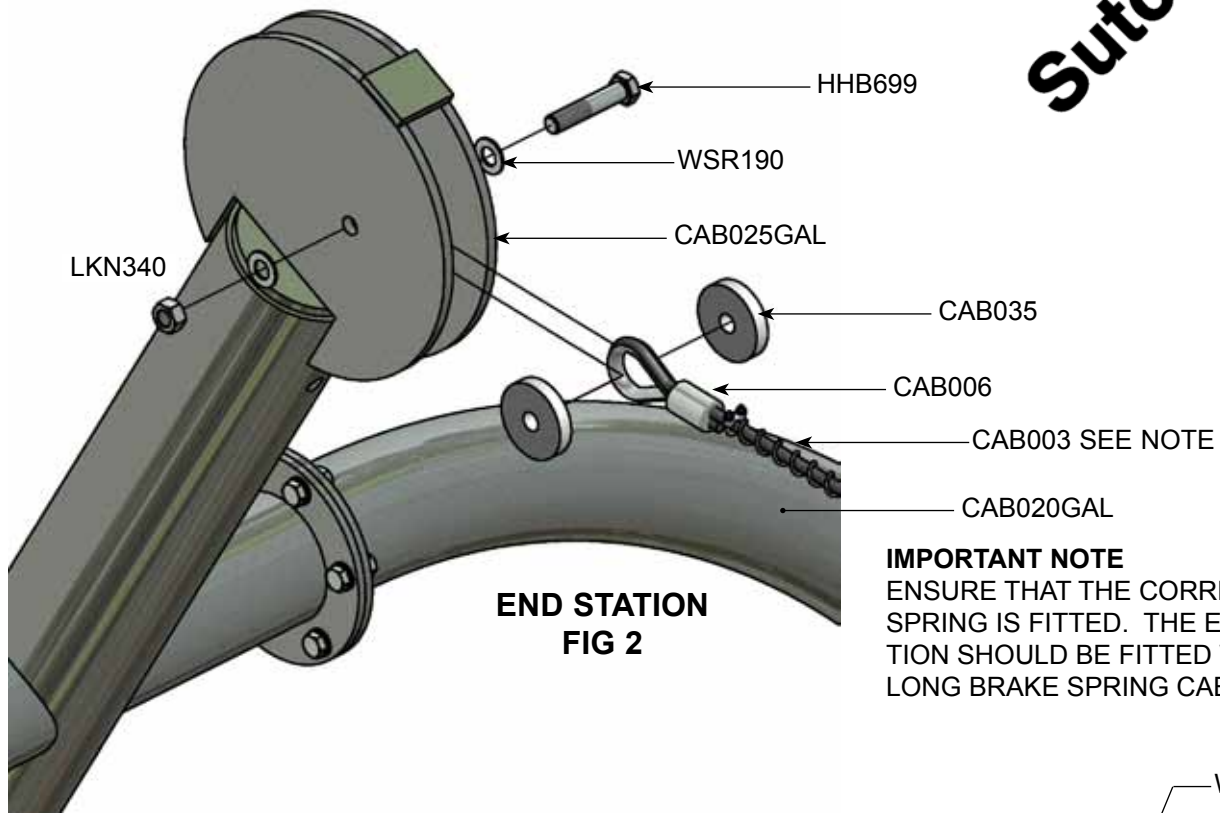

IMPORTANT NOTE
ENSURE THAT THE CORRECT BRAKE
SPRING IS FITTED. THE END STA-
TION SHOULD BE FITTED WITH THE
LONG BRAKE SPRING CAB003.

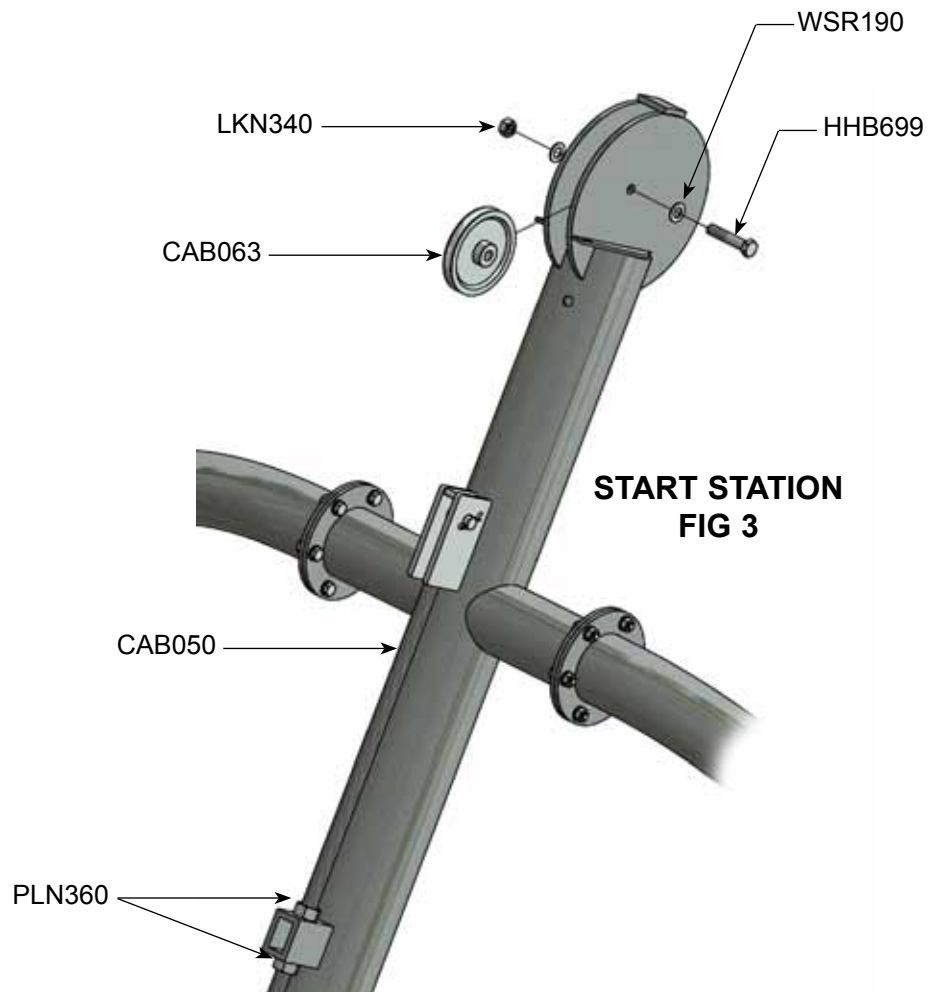

CAM030R

Cableway Installation Instructions

design
make
play
SutcliffePlay

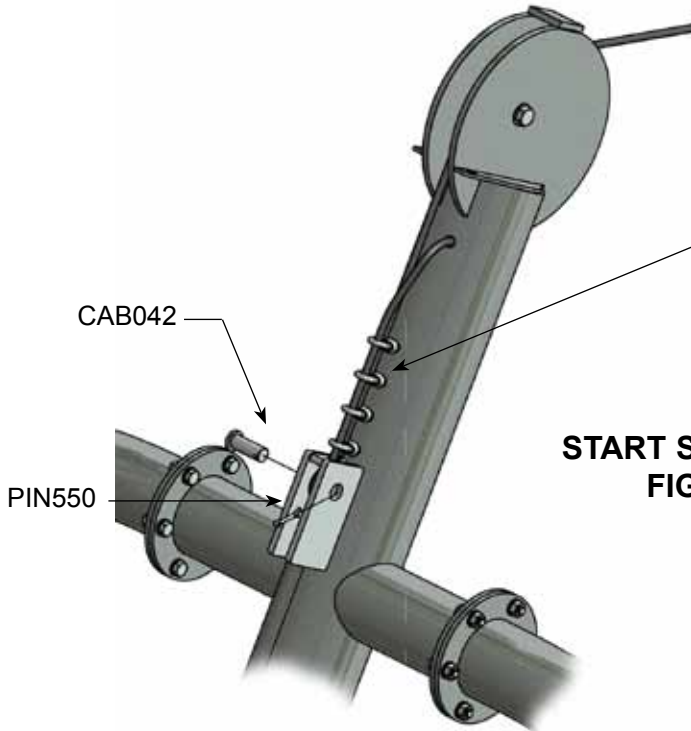

IMPORTANT NOTE

ENSURE THAT THE FOUR WIRE ROPE GRIPS ARE FITTED IN THIS ORIENTATION, WITH THE BRIDGE PART ON THE WORKING SIDE OF CABLE. SPACING BETWEEN THE GRIPS TO BE 50MM.

**START STATION
FIG 4**

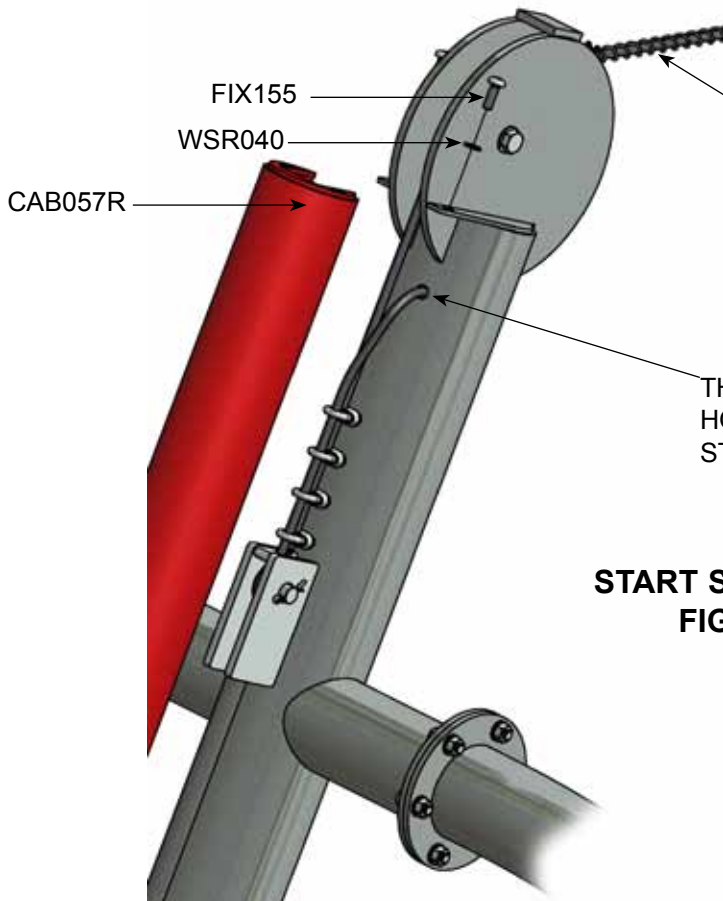
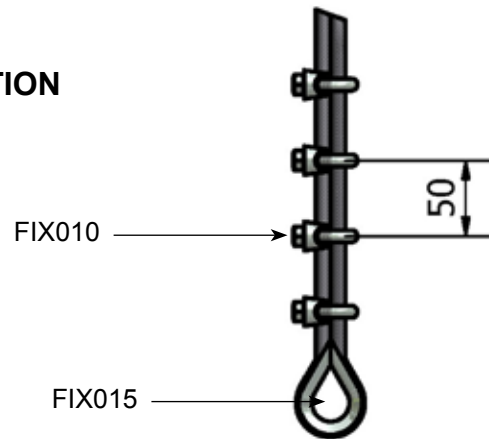

IMPORTANT NOTE

ENSURE THAT THE CORRECT BRAKE SPRING IS FITTED. THE START STATION SHOULD BE FITTED WITH THE SHORT BRAKE SPRING CAB002.

THREAD ANY SPARE CABLE INTO THE HOLE AT THE BACK OF THE START STATION POST.

**START STATION
FIG 5**

CAM030R

Cableway Maintenance Instructions

NOTE

The warranty is invalidated if these instructions are not followed.



Recommended Regular Inspection and Maintenance

	Interval Days				
	7	14	28	56	365
Check stability of structure, tighten connections if required.	<input type="checkbox"/>	<input type="checkbox"/>	<input type="checkbox"/>	<input checked="" type="checkbox"/>	<input type="checkbox"/>
Check all uprights at ground level for corrosion and/or rot. Replace any defective parts.	<input type="checkbox"/>	<input type="checkbox"/>	<input type="checkbox"/>	<input type="checkbox"/>	<input checked="" type="checkbox"/>
Check all painted elements for damage, rub down and repaint or replace as required.	<input type="checkbox"/>	<input type="checkbox"/>	<input type="checkbox"/>	<input checked="" type="checkbox"/>	<input type="checkbox"/>
Check chain/ropework assemblies for wear and damage, replace if required.	<input type="checkbox"/>	<input type="checkbox"/>	<input checked="" type="checkbox"/>	<input type="checkbox"/>	<input type="checkbox"/>
Check rotating and pivot points for wear and smooth running lubricate or replace if required.	<input type="checkbox"/>	<input type="checkbox"/>	<input checked="" type="checkbox"/>	<input type="checkbox"/>	<input type="checkbox"/>
Check rubber parts for wear and/or damage, replace if required.	<input type="checkbox"/>	<input type="checkbox"/>	<input checked="" type="checkbox"/>	<input type="checkbox"/>	<input type="checkbox"/>
Check tension cables, adjust if required.	<input type="checkbox"/>	<input type="checkbox"/>	<input checked="" type="checkbox"/>	<input type="checkbox"/>	<input type="checkbox"/>
Check wear of cables, replace if required.	<input type="checkbox"/>	<input type="checkbox"/>	<input checked="" type="checkbox"/>	<input type="checkbox"/>	<input type="checkbox"/>
Check rubber safety surfaces for damage and poor performance, repair or replace if required.	<input type="checkbox"/>	<input type="checkbox"/>	<input type="checkbox"/>	<input checked="" type="checkbox"/>	<input type="checkbox"/>
Check loose fill safety surfaces, remove any foreign elements, rake level and top up if required.	<input type="checkbox"/>	<input type="checkbox"/>	<input type="checkbox"/>	<input checked="" type="checkbox"/>	<input type="checkbox"/>

Disposal Instructions

All components should be broken down into categories of:-

- 1 **Mild Steel** - all Swing Frames, Playzone, Toddlerzone, Teenzone activities, Deck Frames and Springie Frames.
- 2 **Stainless Steel** - all Slides, Mirror Panels.
- 3 **Aluminium** - all Playzone and Toddlerzone Posts.
- 4 **Galvanised Steel** - all Chains and Teenzone Posts.
- 5 **Moulded Rubber Products without steel inserts** - all Toddlerzone Caps and edge details.
- 6 **Timber** - all natural timber, plywood, and MDF panels.

Wherever possible these materials should be taken to specialist recycling organisations and recycled.

In some cases where composite materials are used, then disposal at land fill sites is the only alternative such as:

- 7 **Moulded Rubber Products encasing steel inserts** - all Swing Seats, Deck Tops, Duo/Dizzy Disc Tops.
- 8 **High Pressure Laminate** - all Toddlerzone, Playzone and Teenzone Panels.
- 9 **Steel Core Polypropylene Rope** - all Scramble Nets, Space Nets, Playzone/Toddlerzone Ropes.